



VX-2R

Technical Supplement

©2003 VERTEX STANDARD CO., LTD. EH015M90A

VERTEX STANDARD CO., LTD.

4-8-8 Nakameguro, Meguro-Ku, Tokyo 153-8644, Japan

VERTEX STANDARD

US Headquarters

10900 Walker Street, Cypress, CA 90630, U.S.A.

International Division

8350 N.W. 52nd Terrace, Suite 201, Miami, FL 33166, U.S.A.

YAESU EUROPE B.V.

P.O. Box 75525, 1118 ZN Schiphol, The Netherlands

YAESU UK LTD.

Unit 12, Sun Valley Business Park, Winnall Close
Winchester, Hampshire, SO23 0LB, U.K.

VERTEX STANDARD HK LTD.

Unit 5, 20/F., Seaview Centre, 139-141 Hoi Bun Road,
Kwun Tong, Kowloon, Hong Kong

Downloaded by
RadioAmateur.EU

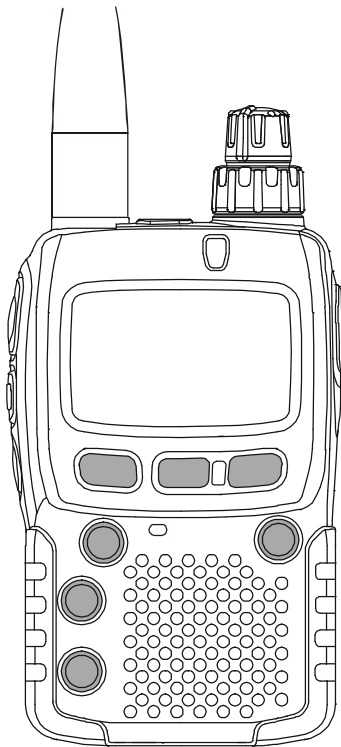

Introduction

This manual provides the technical information necessary for servicing the **VX-2R** VHF/UHF Ultra-Compact Dual-Band Transceiver with Wide Band Coverage.

Servicing this equipment requires expertise in handling surface-mount chip components. Attempts by non-qualified persons to service this equipment may result in permanent damage not covered by the warranty, and may be illegal in some countries.

Two PCB layout diagrams are provided for each double-sided board in this transceiver. Each side of the board is referred to by the type of the majority of components installed on that side ("Side A" or "Side B"). In most cases one side has only chip components (surface-mount devices), and the other has either a mixture of both chip and leaded components (trimmers, coils, electrolytic capacitors, ICs, etc.), or leaded components only.

As described in the pages to follow, the advanced microprocessor design of the **VX-2R** allows a complete alignment of this transceiver to be performed without opening the case of the radio; all adjustments can be performed from the front panel, using the "Alignment Mode" menu.

While we believe the information in this manual to be correct, VERTEX STANDARD assumes no liability for damage that may occur as a result of typographical or other errors that may be present. Your cooperation in pointing out any inconsistencies in the technical information would be appreciated.

Contents

Specifications	2
Exploded View & Miscellaneous Parts	4
Connection Diagram	5
Block Diagram	6
Circuit Description	7
Alignment	11
Board Units (Schematics, Layouts & Parts)	
MAIN Unit	17
FILTER Unit	33
SW Unit	37
VCO Unit	39

Specifications

Downloaded by
RadioAmateur.EU

General

Frequency Ranges:
(USA Version)

RX 0.5-1.8 MHz (BC Band)
1.8-30 MHz (SW Band)
30-76 (59) MHz (50 MHz HAM)
76 (59)-108 MHz (FM)
108-137 MHz (Air Band)
137-174 MHz (144 MHz HAM)
174-222 MHz (VHF TV)
222-420 MHz (ACT1)
420-470 MHz (430 MHz HAM)
470-800 (729) MHz (UHF TV)
(758-774) MHz (UHF TV)
800-999 MHz (ACT2; USA Cellular Blocked)

TX 144-146 (148) MHz
430-440 (450) MHz

Channel Steps:

5/9/10/12.5/15/20/25/50/100 kHz

Frequency Stability:

±5 ppm (14 °F to +140 °C [-10 °C to +60 °C])

Repeater Shift:

±600 kHz (144 MHz)
±1.6/5.0/7.6 MHz (430 MHz)

Emission Type:

F2 , F3

Antenna Impedance:

50 Ω

Supply Voltage:

Nominal: 3.7 V DC, Negative Ground
Operating: 3.2 - 7.0 V, Negative Ground (EXT DC Jack)
5.5 - 7.0 V, Negative Ground (EXT DC Jack with Charging)

Current Consumption:

150 mA (Receive)
58 mA (Standby, Saver Off)
20 mA (Standby, Saver On)
200 μA (Auto Power Off)
1.3 A (1.5 W Tx , 144 MHz) 3.7 V DC
1.8 A (3 W Tx , 144 MHz) 6.0 V DC
1.2 A (1 W Tx , 430 MHz) 3.7 V DC
1.5 A (2 W Tx , 430 MHz) 6.0 V DC

Operating Temperature:

-4 °F to +140 °F (-20 °C to +60 °C)

Case Size (W x H x D):

1.9 x 3.2 x 0.9 inch (47 x 81 x 23 mm) (W/O knob & antenna)

Weight:

4.6 oz (132 g) With FNB-82LI & antenna

Transmitter

RF Power Output:

1.5 W (@ 3.7 V FNB-82LI 144 MHz)
3 W (@ 6.0 V EXT DC IN 144 MHz)
1 W (@ 3.7 V FNB-82LI 430 MHz)
2 W (@ 6.0 V EXT DC IN 430 MHz)

Modulation Type:

Variable Reactance F2 , F3

Maximum Deviation:

±5 kHz (F2, F3)

Spurious Emission:

At least 60 dB below (HIGH)
At least 50 dB below (LOW)

Microphone Impedance:

2 kΩ

Receiver

Circuit Type:	AM, NFM: Double-Conversion Superheterodyne WFM: Triple-Conversion Superheterodyne		
Intermediate Frequencies:	1st	2nd	3rd
	AM, NFM	47.25MHz	450 kHz –
	WFM	45.8 MHz	10.7 MHz 1 MHz
Sensitivity:	3 μ V for 10 dB SN (0.5-30 MHz, AM) 0.35 μ V TYP for 12 dB SINAD (30-54 MHz, NFM) 1 μ V TYP for 12 dB SINAD (54-76 MHz, NFM) 1.5 μ V TYP for 12 dB SINAD (76-108 MHz, WFM) 1.5 μ V TYP for 10 dB SN (108-137 MHz, AM) 0.2 μ V for 12 dB SINAD (137-140 MHz, NFM) 0.16 μ V for 12 dB SINAD (140-150 MHz, NFM) 0.2 μ V for 12 dB SINAD (150-174 MHz, NFM) 1 μ V TYP for 12 dB SINAD (174-222 MHz, WFM) 0.5 μ V for 12 dB SINAD (300-350 MHz, NFM) 0.2 μ V for 12 dB SINAD (350-400 MHz, NFM) 0.18 μ V for 12 dB SINAD (400-470 MHz, NFM) 1.5 μ V for 12 dB SINAD (470-540 MHz, WFM) 3 μ V TYP for 12 dB SINAD (540-800 MHz, WFM) 1.5 μ V TYP for 12 dB SINAD (800 -999 MHz, NFM) USA Version Cellular Blocked		
Selectivity:	NFM, AM: 12 kHz/35 kHz (-6 dB/-60 dB) WFM: 200 kHz/300 kHz (-6 dB/-20 dB)		
AF Output:	50 mW @ 8 W for 10 % THD (@ 3.7 V) 100 mW @ 8 W for 10 % THD (@ 6.0 V)		

Downloaded by
RadioAmateur.EU

Specifications are subject to change without notice, and are guaranteed within the 144 and 430 MHz amateur bands only. Frequency ranges will vary according to transceiver version; check with your dealer.

Exploded View & Miscellaneous Parts

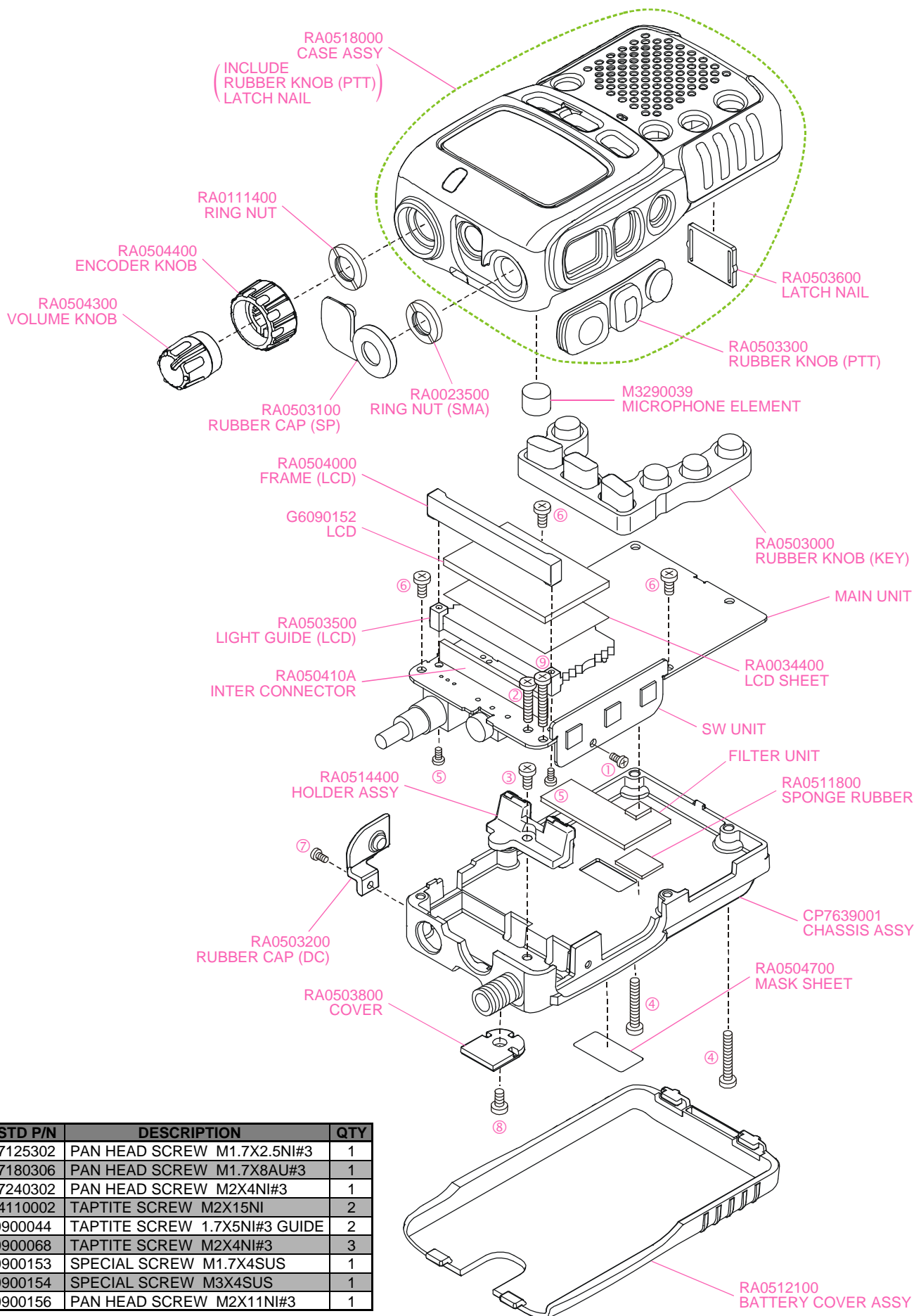

REF	VXSTD P/N	DESCRIPTION	QTY
①	U07125302	PAN HEAD SCREW M1.7X2.5NI#3	1
②	U07180306	PAN HEAD SCREW M1.7X8AU#3	1
③	U07240302	PAN HEAD SCREW M2X4NI#3	1
④	U44110002	TAPTITE SCREW M2X15NI	2
⑤	U9900044	TAPTITE SCREW 1.7X5NI#3 GUIDE	2
⑥	U9900068	TAPTITE SCREW M2X4NI#3	3
⑦	U9900153	SPECIAL SCREW M1.7X4SUS	1
⑧	U9900154	SPECIAL SCREW M3X4SUS	1
⑨	U9900156	PAN HEAD SCREW M2X11NI#3	1

Downloaded by  RadioAmateur.EU

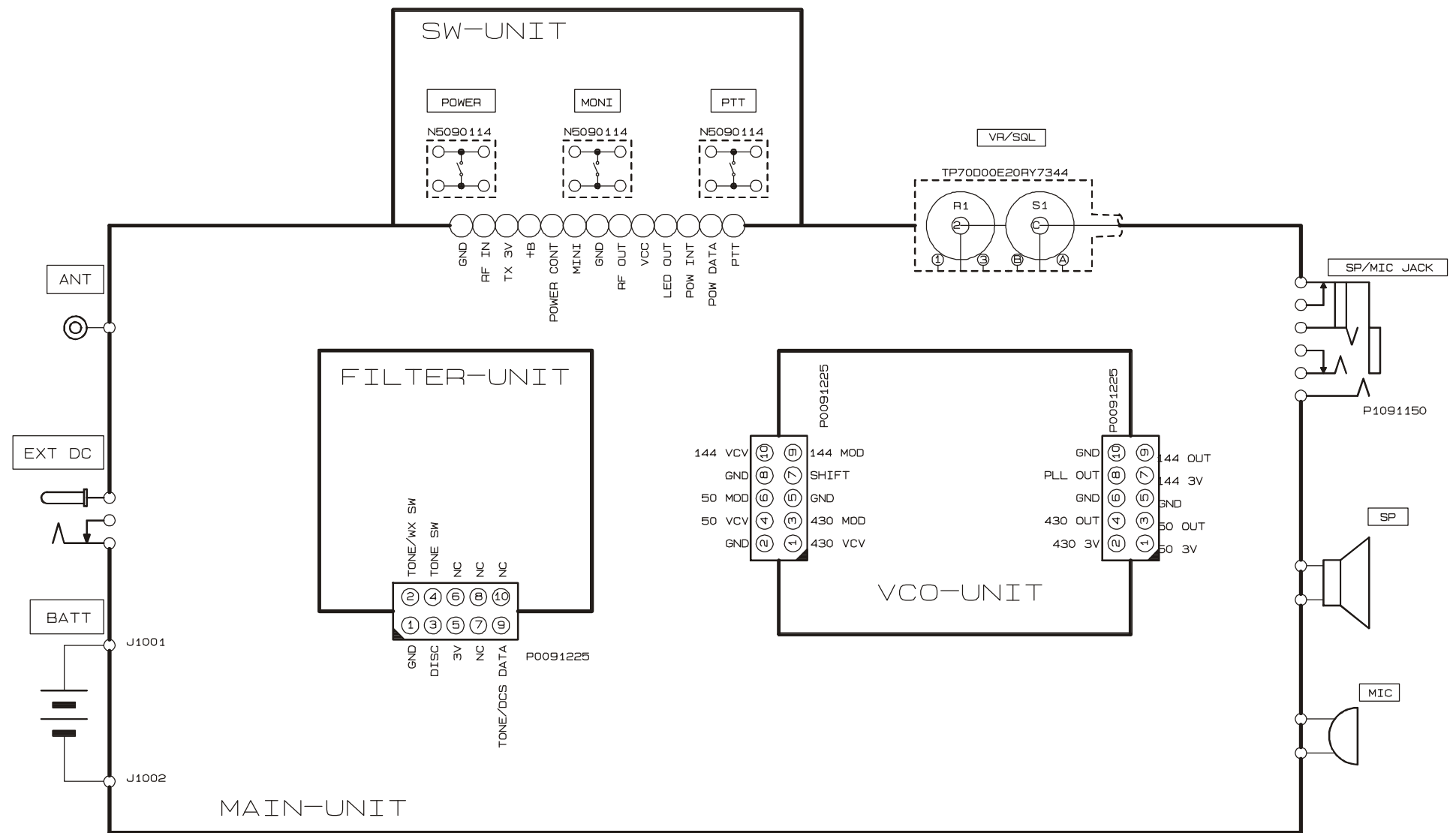

Block Diagram

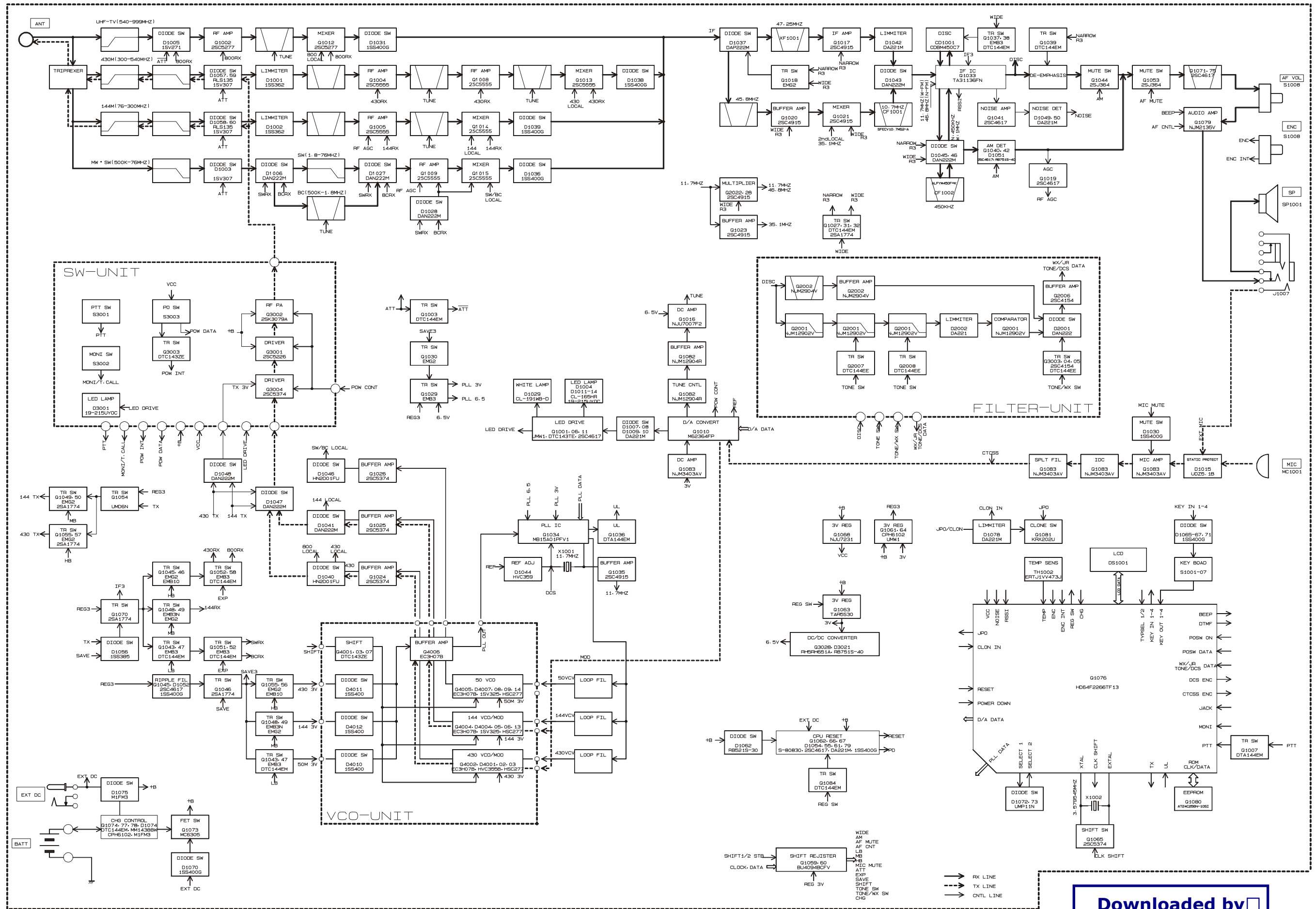

Circuit Description

The **VX-2R** consists of a MAIN-UNIT, a FILTER-UNIT, a SW-UNIT, and a VCO-UNIT. The MAIN-UNIT contains the receiver front end, IF circuit, PLL circuit, the CPU, audio ICs, and the power circuitry for the LCD. The FILTER-UNIT contains the CTCSS/DCS Encoder/Decoder circuit. The SW-UNIT contains the TX power amplifier circuit and power switching circuits. The VCO-UNIT contains the transmit/receive local signal oscillator and transmit modulator circuit.

Receiver Signal Flow

The **VX-2R** includes four receiver front ends, each optimized for a particular frequency range and mode combination.

(1) *Triplexer*

Signals between 0.5 and 540 MHz received at the antenna terminal pass through a first low-pass filter composed of L1053, L1056, C1300, and C1302.

Received 430-MHz signals, after passing through a low-pass filter, are fed to the UHF T/R switch circuit composed of diode switch **D1057 (RLS135)** and **D1059 (1SV307)**.

Received 145-MHz signals, after passing through a low-pass filter, are fed to the VHF T/R switch circuit composed of diode switch **D1058 (RLS135)** and **D1060 (1SV307)**.

(2) *145-MHz Band and 76-300MHz Reception*

Received signals between 140 and 150 MHz pass through the Triplexer circuit, a low-pass filter/high-pass filter circuit, VHF T/R switch circuit, and protector diode **D1002 (1SS362)** before additional filtering by a band-pass filter prior to application to RF amplifier **Q1005 (2SC5555)**. The amplified RF signal is passed through a band-pass filter to first mixer **Q1014 (2SC5555)**. Meanwhile, the first local signal for the VHF band from the VCO-UNIT is amplified by **Q1025 (2SC5374)** and applied through diode T/R switch **D1041 (DAN222M)** to mixer **Q1014 (2SC5555)** as the first local signal.

The 47.25-MHz intermediate frequency product of the mixer is delivered to the IF circuit.

The TUNE voltage from the CPU is amplified by DC amplifier **Q1016 (NJU7007)** and applied to varactors **D1020 (1SV325)**, **D1021 (1SV325)**, **D1022 (HVC369)**, **D1023 (1SV325)**, **D1024 (1SV325)**, **D1025 (HVC369)**, **D1034 (1SV325)**, and **D1035 (1SV325)** in the variable frequency band-pass filters. By changing the electrostatic capacitance of the varactors, optimum filter characteristics are provided for each specific operating frequency.

(3) *435-MHz Band and 300-540MHz Reception*

Received signals between 430 and 450 MHz pass through the Triplexer circuit, a low-pass filter/high-pass filter circuit, UHF T/R switch circuit, and protector diode **D1001**

(1SS362) before additional filtering by a band-pass filter prior to application to RF amplifier **Q1004 (2SC5555)**. The amplified RF signal is passed through a band-pass filter, RF amplifier **Q1008 (2SC5555)**, and another band-pass filter to first mixer **Q1013 (2SC5555)**. Meanwhile, the first local signal for the UHF band from the VCO-UNIT is amplified by **Q1024 (2SC5374)** and applied through diode T/R switch **D1040 (HN2D01FU)** to mixer **Q1013 (2SC5555)** as the first local signal.

The 47.25-MHz intermediate frequency product of the mixer is delivered to the IF circuit.

The TUNE voltage from the CPU is amplified by DC amplifier **Q1016 (NJU7007)** and applied to varactors **D1018**, **D1019**, **D1032**, and **D1033** (all **HVC358**) in the variable frequency band-pass filters. By changing the electrostatic capacitance of the varactors, optimum filter characteristics are provided for each specific operating frequency.

(4) *0.5-76 MHz Reception*

Received signals between 0.5 and 76 MHz pass through the Triplexer circuit, a low-pass filter circuit, T/R switch circuit, and protector diode **D1003 (1SV307)** before additional filtering by a band-pass filter prior to application to RF amplifier **Q1009 (2SC5555)**. The amplified RF signal is passed through the band-pass filter to first mixer **Q1015 (2SC5555)**. Meanwhile, the first local signal for the BC/SW band from the VCO-UNIT is amplified by **Q1026 (2SC5374)** and fed to mixer **Q1015 (2SC5555)** as the first local signal.

The 47.25-MHz intermediate frequency product of the mixer is delivered to the IF circuit.

The TUNE voltage from the CPU is amplified by DC amplifier **Q1016 (NJU7007)** and applied to varactors **D1026 (HVR100)** in the variable frequency band-pass filters. By changing the electrostatic capacitance of the varactors, optimum filter characteristics are provided for each specific operating frequency.

(5) *540 - 999 MHz Reception*

Received signals between 540 and 999 MHz pass through a high-pass filter circuit and T/R switch **D1005 (1SV271)** prior to application to RF amplifier **Q1002 (2SC5277)**. The amplified RF signal is passed through a band-pass filter to first mixer **Q1012 (2SC5277)**. Meanwhile, the first local signal for the UHF band from the VCO-UNIT is amplified by **Q1024 (2SC5374)** and applied through diode T/R switch **D1040 (HN2D01FU)** to mixer **Q1012 (2SC5277)** as the first local signal.

The 47.25-MHz intermediate frequency product of the mixer is delivered to the IF circuit.

The TUNE voltage from the CPU on the CNTL-UNIT is amplified by DC amplifier **Q1016 (NJU7007)** and applied

Circuit Description

to varactors **D1016** and **D1017** (both **HVC355B**) in the variable frequency band-pass filters. By changing the electrostatic capacitance of the varactors, optimum filter characteristics are provided for each specific operating frequency.

(6) 47.25-MHz First Intermediate Frequency

The 47.25-MHz first intermediate frequency from first mixers is delivered to the first IF circuit. On the MAIN-UNIT, the first IF signals on the AM and FM-narrow are passed through NAR/WIDE switch **D1037** (**DAP222M**), 47.25-MHz monolithic crystal filter (MCF) **XF1001**, and narrow IF amplifier **Q1017** (**2SC4915**) to pin 16 of Narrow IF IC **Q1033** (**TA31136FN**) after amplitude limiting by **D1042** (**DA221M**).

Meanwhile, a portion of the output of 11.7-MHz crystal **X1001** is multiplied fourfold by **Q1035** and **Q1022** (both **2SC4915**) to provide the 46.8-MHz second local signal, applied to the Narrow IF IC **Q1033** (**TA31136FN**). Within this IC, the 46.8-MHz second local signal is mixed with the 47.25-MHz first intermediate frequency signal to produce the 450-kHz second intermediate frequency.

This second IF signal is filtered by ceramic filter **CF1002** and amplified by the limiting amplifier within the Narrow IF IC **Q1033** (**TA31136FN**) before quadrature detection by ceramic discriminator **CD1001**.

Demodulated audio is fed from pin 9 of the Narrow IF IC **Q1033** (**TA31136FN**) through the "narrow mute" analog switch **Q1044** and squelch gate **Q1053** (both **2SJ364**) before de-emphasis at **Q1039** (**DTC144EM**).

The resulting audio is amplified by AF amplifier **Q1079** (**NJM2135V**), and fed through **MIC/EAR** jack **J1007** to the internal speaker, **SP1001**, or an external earphone.

(7) Squelch Control

Signal components in the neighborhood of 15 kHz contained in the discriminator output pass through an active band-pass filter composed of **R1142**, **R1156**, **R1160**, **C1168**, **C1177**, and the operational amplifier between pins 7 and 8 within Narrow IF IC **Q1033** (**TA31136FN**). They are then rectified by **D1049** and **D1050** (both **DA221M**) to obtain a DC voltage corresponding to the level of noise. This voltage is fed to pin 51 of CPU **Q1076** (**HD64F2266**), which compares the input voltage with a previously set threshold. When the input voltage drops below the threshold, normally due to the presence of a carrier, squelch gate **Q1071** (**2SC4617**) turns on and allows any demodulated audio to pass. At the same time, **Q1001** (**UMW1N**) switches on, causing the **BUSY/TX** lamp **D1004** (**CL-165**) to light.

Transmitter Signal Flow

(1) 145-MHz-Band T/R Switching

Closing **PTT** switch **S3001** on the SW-UNIT pulls the base of **Q1007** (**DTA114EM**) low, causing the collector to go high. This signal is fed to pin 45 (**PTT**) of CPU **Q1076** (**HD64F2266**), allowing the CPU to recognize that the **PTT** switch has been pushed. When the CPU detects closure of the **PTT** switch, pin 70 (**TX/RX**) goes high. This control signal switches **Q1054** (**UMD6N**) to produce the **TX** control signal that activates **Q1050** (**2SA1774**). At the same time, **PLL** division data is applied to **PLL** IC **Q1034** (**MB15A01PFV**) from the CPU, to disable the receiver power saver. Also, **Q1049** (**EMG2**) is switched on to disable the receiver circuits, causing the red side of **BUSY/TX** lamp **D1004** (**CL-165**) to light.

(2) Modulation

Voice signal input from either the built-in microphone **MC1001** on the MAIN-UNIT or external microphone input from external mic jack **J1007** is pre-emphasized by **C1036** and **R1031**, and processed by microphone amplifier **Q1083** (**NJM3403AV**), the **IDC** (instantaneous deviation control) circuit **Q1083** to prevent over-modulation, and active low-pass filter **Q1083**.

During **CTCSS** operation, the voice signal is mixed with the **TONE ENC** subaudible tone signal from pin 43 of the CPU and delivered to the **VCO**. During **DCS** operation, the voice signal is mixed with the **DCS ENC** subaudible tone signal from pin 44 of the CPU and delivered to the **VCO**. During **DTMF** operation, the **DTMF** tones from pin 44 of the CPU are fed directly to the **IDC** stage.

(3) 145-MHz-Band Transmission

Modulating audio passes through deviation setting **D/A** converter **Q1010** (**M62364FP**), then delivered to the **VHF** modulator of the **VCO-UNIT** mounted on the MAIN-UNIT. This signal is applied to varactor **D4005** (**HSC277**) in the tank circuit of **VHF VCO** **Q4004** (**EC3H07B**), which oscillates at the desired **VHF** transmitting frequency. The modulated **VCO** signal is buffered by amplifier **Q4006** (**EC3H07B**) and **Q1025** (**2SC5374**) and delivered through **VHF T/R** diode switch **D1041** (**DAN222M**) to the MAIN-UNIT. The modulated low-level **VHF** transmit signal from the **VCO** is passed through diode switch **D1047** (**DAN222M**) to amplifier **Q3004** (**2SC5374**) on the SW-UNIT. The amplified **VHF** transmit signal from **Q3004** (**2SC5374**) is amplified by **Q3001** (**2SC5226**) and **RF** power amplifier **Q3002** (**2SK3079**) on the SW-UNIT up to 0.1, 0.3, 1.5, or 3 Watts (depending on the power source). The **RF** output passes through **TX** diode switch **D1058** (**RLS135**) then fed via the **T/R** switch and low-pass filter (to suppress harmonics and spurious products) to the antenna terminal.

(4) 435-MHz-Band Transmission

Modulating audio passes through deviation setting D/A converter **Q1010 (M62364FP)** then delivered to the UHF modulator of the VCO-UNIT mounted on the MAIN-UNIT. This signal is applied to varactor **D4002 (HSC277)** in the tank circuit of UHF VCO **Q4002 (EC3H07B)**, which oscillates at the desired UHF transmitting frequency. The modulated VCO signal is buffered by amplifier **Q4006 (EC3H07B)** and **Q1024 (2SC5374)** and delivered through UHF T/R diode switch **D1040 (HN2D01FU)** to the MAIN-UNIT. The modulated low-level UHF transmit signal from the VCO is passed through diode switch **D1047 (DAN222M)** to amplifier **Q3004 (2SC5374)** on the SW-UNIT. The amplified UHF transmit signal from **Q3004 (2SC5374)** is amplified by **Q3001 (2SC5226)** and RF power amplifier **Q3002 (2SK3079)** on the SW-UNIT up to 0.1, 0.3, 1.0, or 2 Watts (depending on the power source). The RF output passes through TX diode switch **D1057 (RLS135)** then fed via the T/R switch and low-pass filter to the antenna terminal.

PLL Frequency Synthesizer

PLL IC **Q1034 (MB15A01PFV)** on the MAIN-UNIT consists of a data shift register, reference frequency divider, phase comparator, charge pump, intermittent operation circuit, and band selector switch. Serial PLL data from the CPU is converted into parallel data by the shift register in the PLL IC **Q1034 (MB15A01PFV)** and is latched into the comparative frequency divider and reference frequency divider to set a frequency dividing ratio for each. An 11.7-MHz reference signal produced by **X1001** is fed to REF pin 1 of the PLL IC **Q1034 (MB15A01PFV)**. The internal reference frequency divider divides the 11.7-MHz reference by 2,050 (or 1,640) to obtain a reference frequency of 5 kHz (or 6.25 kHz), which is applied to the phase comparator. Meanwhile, a sample of the output of VHF VCO **Q4004** or UHF VCO **Q4002** (both **EC3H07B**) on the VCO-UNIT, buffered by **Q4007 (DTC144ZE)**, is fed to the PLL IC, where the frequency is divided by the internal comparative frequency divider to produce a comparison frequency which also is applied to the phase comparator. The phase comparator compares the phase between the reference frequency and comparison frequency to output a pulse corresponding to the phase difference between them. This pulse is fed to the charge pump, and the output from the charge pump passes through a loop filter composed of L1036, R1152, C1166, and either R1153, C1167, R1172 and C1193, for VHF, or R1149, C1162, R1171, and C1192 for UHF, which converts the pulse into a corresponding smoothed varactor control voltage (VCV). The VCV is applied to varactor **D4004** and **D4013** (both **1SV325**) in the VHF VCO tank circuit, or to varactor **D4001 (HVC355B)** in the UHF VCO tank circuit, to eliminate

phase difference between the reference frequency and comparative frequency, thus locking the VCO oscillation frequency to the reference crystal. The VCO frequency is determined by the frequency-dividing ratio sent from the CPU to the PLL IC. During receiver power save operation, the PLL circuit operates intermittently to reduce current consumption, for which the intermittent operation control circuit reduces the lock-up time.

Circuit Description

Note

Introduction

The **VX-2R** is carefully aligned at the factory for the specified performance across the amateur band. Realignment should therefore not be necessary except in the event of a component failure. Only an authorized Vertex Standard representative should perform all component replacement and service, or the warranty policy may be void.

The following procedures cover the adjustments that are not normally required once the transceiver has left the factory. However, if damage occurs and some parts subsequently are replaced, realignment may be required. If a sudden problem occurs during normal operation, it is likely due to component failure; realignment should not be done until after the faulty component has been replaced.

We recommend that servicing be performed only by authorized Vertex Standard service technicians who are experienced with the circuitry and fully equipped for repair and alignment. If a fault is suspected, contact the dealer from whom the transceiver was purchased for instructions regarding repair. Authorized Vertex Standard service technicians realign all circuits and make complete performance checks to ensure compliance with factory specifications after replacing any faulty components.

Those who do undertake any of the following alignments are cautioned to proceed at their own risk. Problems caused by unauthorized attempts at realignment are not covered by the warranty policy. Also, Vertex Standard reserves the right to change circuits and alignment procedures in the interest of improved performance, without notifying owners.

Under no circumstances should any alignment be attempted unless the normal function and operation of the transceiver are clearly understood, the cause of the malfunction has been clearly pinpointed and any faulty components replaced, and realignment determined to be absolutely necessary.

Required Test Equipment

The following test equipment (and familiarity with its use) is necessary for complete realignment. Correction of problems caused by misalignment resulting from use of improper test equipment is not covered under the warranty policy. While most steps do not require all of the equipment listed, the interactions of some adjustments may require that more complex adjustments be performed afterwards.

Do not attempt to perform only a single step unless it is clearly isolated electrically from all other steps. Have all test equipment ready before beginning and, follow all of the steps in a section in the order presented.

- RF Signal Generator with calibrated output level at 500 MHz
- Deviation Meter (linear detector)
- In-line Wattmeter with 5% accuracy at 500 MHz
- 50-Ohm 10-W RF Dummy Load
- 8-Ohm AF Dummy Load
- Regulated DC Power Supply adjustable from 3 to 15 VDC, 2A
- Frequency Counter: 0.2-ppm accuracy at 500 MHz
- AF Signal Generator
- AC Voltmeter
- DC Voltmeter: high impedance
- UHF Sampling Coupler
- SINAD Meter

Alignment Preparation & Precautions

A 50-Ohm RF load and in-line wattmeter must be connected to the main antenna jack in all procedures that call for transmission; alignment is not possible with an antenna. After completing one step, read the next step to see if the same test equipment is required. If not, remove the test equipment (except dummy load and wattmeter, if connected) before proceeding.

Correct alignment requires that the ambient temperature be the same as that of the transceiver and test equipment, and that this temperature be held constant between 68 ~ 86° F (20° ~ 30° C). When the transceiver is brought into the shop from hot or cold air, it should be allowed some time to come to room temperature before alignment. Whenever possible, alignments should be made with oscillator shields and circuit boards firmly affixed in place. Also, the test equipment must be thoroughly warmed up before beginning.

Note: Signal levels in dB referred to in the alignment procedure are based on 0dBm = 0.5µV.

Test Setup

Set up the test equipment as shown below for transceiver alignment, and apply 4.4 V DC power to the transceiver. Refer to the drawings for Alignment Points.

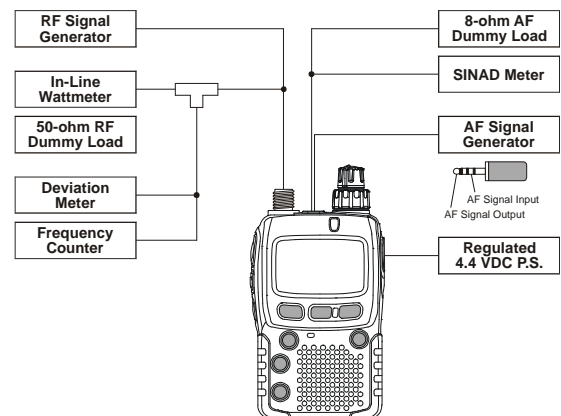

Alignment

Internal System Alignment Routine

This process uses a programmed routine in the transceiver which simplifies many previously complex discrete component settings and adjustments with digitally-controlled settings via front panel keys and LCD indications.

Set the transceiver to the 430MHz band, then turn the transceiver off. Now, press and hold in the [F/W], [MD], and [⊗] keys (at the same time) while powering the radio on again. The display will show the first setting. Thereafter, the frequencies used during alignment will automatically be set without further action by the technician.

In the alignment process, each adjustment is selected by rotating the **DIAL** knob. Alignment is performed by:

- Pressing the [V/M] key;
- Injecting a signal of the required frequency and level; then
- Pressing the [V/M] key after a level setting or adjustment is made. This second pressing of the [V/M] key stores the alignment data at the desired value.

To exit the alignment routine, press the [HM/RV] key. After performing the system alignment in its entirety, individual settings can be returned to and adjusted should the need arise.

PLL Reference Frequency (PLL REF)

- Press the [V/M] key.
- Transmit, and adjust the counter frequency to within ± 300 Hz by rotating the **DIAL** knob; now press the [V/M] key.
- Rotate the **DIAL** knob to select the next setting.

430 MHz Band Alignment

Squelch Hysteresis Adjust (HIS)

- Press the [V/M] key.
- Rotate the **DIAL** knob for minimum squelch hysteresis, then press the [V/M] key.
- Rotate the **DIAL** knob to select the next setting.

Squelch Preset Threshold (tHL)

- Press the [V/M] key.
- Inject a 435.1 MHz, -12 dB μ RF signal (1 kHz tone @ ± 3.5 kHz deviation) to the **ANT** jack, then press the [F/W] key.
- Press the [F/W] key again, then press the [V/M] key.
- Rotate the **DIAL** knob to select the next setting.

Squelch Preset Tight (tIg)

- Press the [V/M] key.
- Adjust the generator level for a -5 dB μ signal (leaving the modulation level unchanged), then press the [F/W] key.
- Press the [F/W] key again, then press the [V/M] key.
- Rotate the **DIAL** knob to select the next setting.

Low-Scale S-1 Adjustment (S1)

- Press the [V/M] key.
- Adjust the generator level to -7 dB μ (leaving the modulation level unchanged), then press the [F/W] key.
- Press the [F/W] key again, then press the [V/M] key.
- Rotate the **DIAL** knob to select the next setting.

S-Meter Full-Scale Adjustment (S9)

- Press the [V/M] key.
- Adjust the generator level to $+20$ dB μ (leaving the modulation level unchanged), then press the [F/W] key.
- Press the [F/W] key again, then press the [V/M] key.
- Rotate the **DIAL** knob to select the next setting.

Wide FM Low-Scale S-1 Adjustment (S1)

- Press the [V/M] key.
- Adjust the generator level to 0 dB μ (1 kHz tone @ ± 20 kHz deviation), then press the [F/W] key.
- Press the [F/W] key again, then press the [V/M] key.
- Rotate the **DIAL** knob to select the next setting.

Wide FM S-Meter Full-Scale Adjustment (S9)

- Press the [V/M] key.
- Adjust the generator level to $+20$ dB μ (leaving the modulation level unchanged from the previous step), then press the [F/W] key.
- Press the [F/W] key again, then press the [V/M] key.
- Rotate the **DIAL** knob to select the next setting.

TX High Power (Low Band Edge @6.0 V) Adjustment (HHP)

- Set the DC power supply voltage to 6.0 V.
- Press the [V/M] key.
- Transmit, and adjust the output power level for 2.0 W (± 0.2 W) by rotating the **DIAL** knob, then press the [V/M] key.
- Rotate the **DIAL** knob to select the next setting.

TX High Power (Low Band Edge @4.4 V) Adjustment (LHP)

- Set the DC power supply voltage to 4.4 V.
- Press the [V/M] key.
- Transmit, and adjust the output power level for 1.0 W (± 0.1 W) by rotating the **DIAL** knob, then press the [V/M] key.
- Rotate the **DIAL** knob to select the next setting.

Alignment

TX Low Power (Low Band Edge) Adjustment (LP)

- Press the [V/M] key.
- Transmit, and adjust the output power level for 0.1 W (± 0.05 W) by rotating the **DIAL** knob, then press the [V/M] key.
- Rotate the **DIAL** knob to select the next setting.

TX Deviation (Low Band Edge) Adjustment (dEV)

- Press the [V/M] key.
- Inject a 1 kHz audio tone at a level of 50 mV (rms) to the **MIC** jack, then press the [F/W] key.
- Transmit, and adjust the deviation for ± 4.2 kHz (± 0.2 kHz) by rotating the **DIAL** knob, then press the [V/M] key.
- Rotate the **DIAL** knob to select the next setting.

CTCSS Tone (67.0 Hz) Deviation (Low Band Edge) Adjustment (670)

- Press the [V/M] key.
- Transmit, and adjust the deviation for ± 0.6 kHz (± 0.05 kHz) by rotating the **DIAL** knob, then press the [V/M] key.
- Rotate the **DIAL** knob to select the next setting.

CTCSS Tone (123.0 Hz) Deviation (Low Band Edge) Adjustment (123)

- Press the [V/M] key.
- Transmit, and adjust the deviation for ± 0.6 kHz (± 0.05 kHz) by rotating the **DIAL** knob, then press the [V/M] key.
- Rotate the **DIAL** knob to select the next setting.

CTCSS Tone (254.1 Hz) Deviation (Low Band Edge) Adjustment (254)

- Press the [V/M] key.
- Transmit, and adjust the deviation for ± 0.6 kHz (± 0.05 kHz) by rotating the **DIAL** knob, then press the [V/M] key.
- Rotate the **DIAL** knob to select the next setting.

DCS Tone Deviation (Low Band Edge) Adjustment (dCS)

- Press the [V/M] key.
- Transmit, and adjust the deviation for ± 0.6 kHz (± 0.05 kHz) by rotating the **DIAL** knob, then press the [V/M] key.
- Rotate the **DIAL** knob to select the Menu Item "HHP," then press the [F/W] key.

TX High Power (High Band Edge @6.0 V) Adjustment (HHP)

- Set the DC power supply voltage to 6.0 V.
- Press the [V/M] key.
- Transmit, and adjust the output power level for 2.0 W (± 0.2 W) by rotating the **DIAL** knob, then press the [V/M] key.
- Rotate the **DIAL** knob to select the next setting.

TX High Power (High Band Edge @4.4 V) Adjustment (LHP)

- Set the DC power supply voltage to 4.4 V.
- Press the [V/M] key.
- Transmit, and adjust the output power level for 1.0 W (± 0.1 W) by rotating the **DIAL** knob, then press the [V/M] key.
- Rotate the **DIAL** knob to select the next setting.

TX Low Power (High Band Edge) Adjustment (LP)

- Press the [V/M] key.
- Transmit, and adjust the output power level for 0.1 W (± 0.05 W) by rotating the **DIAL** knob, then press the [V/M] key.
- Rotate the **DIAL** knob to select the next setting.

TX Deviation (High Band Edge) Adjustment (dEV)

- Press the [V/M] key.
- Inject a 1 kHz audio tone at a level of 50 mV (rms) to the **MIC** jack, then press the [F/W] key.
- Transmit, and adjust the deviation for ± 4.2 kHz (± 0.2 kHz) by rotating the **DIAL** knob, then press the [V/M] key.
- Rotate the **DIAL** knob to select the next setting.

CTCSS Tone (67.0 Hz) Deviation (High Band Edge) Adjustment (670)

- Press the [V/M] key.
- Transmit, and adjust the deviation for ± 0.6 kHz (± 0.05 kHz) by rotating the **DIAL** knob, then press the [V/M] key.
- Rotate the **DIAL** knob to select the next setting.

CTCSS Tone (123.0 Hz) Deviation (High Band Edge) Adjustment (123)

- Press the [V/M] key.
- Transmit, and adjust the deviation for ± 0.6 kHz (± 0.05 kHz) by rotating the **DIAL** knob, then press the [V/M] key.
- Rotate the **DIAL** knob to select the next setting.

Alignment

CTCSS Tone (254.1 Hz) Deviation (High Band Edge)

Adjustment (254)

- Press the [V/M] key.
- Transmit, and adjust the deviation for ± 0.6 kHz (± 0.05 kHz) by rotating the **DIAL** knob, then press the [V/M] key.
- Rotate the **DIAL** knob to select the next setting.

DCS Tone Deviation (High Band Edge) Adjustment (dCS)

- Press the [V/M] key.
- Transmit, and adjust the deviation for ± 0.6 kHz (± 0.05 kHz) by rotating the **DIAL** knob, then press the [V/M] key.
- Rotate the **DIAL** knob to select the Menu Item "HIS," then press the [BAND] key.

50MHz Band Alignment (Receive Only)

Squelch Hysteresis Adjust (HIS)

- Press the [V/M] key.
- Rotate the **DIAL** knob for minimum squelch hysteresis, then press the [V/M] key.
- Rotate the **DIAL** knob to select the next setting.

Squelch Preset Threshold (tHL)

- Press the [V/M] key.
- Inject a 52.1 MHz, -10 dB μ RF signal (1 kHz tone @ ± 3.5 kHz deviation) to the **ANT** jack, then press the [F/W] key.
- Press the [F/W] key again, then press the [V/M] key.
- Rotate the **DIAL** knob to select the next setting.

Squelch Preset Tight (tIg)

- Press the [V/M] key.
- Adjust the generator level for a 0 dB μ signal (leaving the modulation level unchanged), then press the [F/W] key.
- Press the [F/W] key again, then press the [V/M] key.
- Rotate the **DIAL** knob to select the next setting.

Low-Scale S-1 Adjustment (S1)

- Press the [V/M] key.
- Adjust the generator level to -2 dB μ (leaving the modulation level unchanged), then press the [F/W] key.
- Press the [F/W] key again, then press the [V/M] key.
- Rotate the **DIAL** knob to select the next setting.

S-Meter Full-Scale Adjustment (S9)

- Press the [V/M] key.
- Adjust the generator level to $+20$ dB μ (leaving the modulation level unchanged), then press the [F/W] key.
- Press the [F/W] key again, then press the [V/M] key.
- Rotate the **DIAL** knob to select the next setting.

Wide FM Low-Scale S-1 Adjustment (S1)

- Press the [V/M] key.
- Adjust the generator level to $+8$ dB μ (1 kHz tone @ ± 20 kHz deviation), then press the [F/W] key.
- Press the [F/W] key again, then press the [V/M] key.
- Rotate the **DIAL** knob to select the next setting.

Wide FM S-Meter Full-Scale Adjustment (S9)

- Press the [V/M] key.
- Adjust the generator level to $+25$ dB μ (leaving the modulation level unchanged from the previous step), then press the [F/W] key.
- Press the [F/W] key again, then press the [V/M] key.
- Press the [BAND] key to select the next setting.

144MHz Band Alignment

Squelch Hysteresis Adjustment (HIS)

- Press the [V/M] key.
- Rotate the **DIAL** knob for minimum squelch hysteresis, then press the [V/M] key.
- Rotate the **DIAL** knob to select the next setting.

Squelch Preset Threshold (tHL)

- Press the [V/M] key.
- Inject a 145.1 MHz, -15 dB μ RF signal (1 kHz tone @ ± 3.5 kHz deviation) to the **ANT** jack, then press the [F/W] key.
- Press the [F/W] key again, then press the [V/M] key.
- Rotate the **DIAL** knob to select the next setting.

Squelch Preset Tight (tIg)

- Press the [V/M] key.
- Adjust the generator level for a -4 dB μ signal (leaving the modulation level unchanged), then press the [F/W] key.
- Press the [F/W] key again, then press the [V/M] key.
- Rotate the **DIAL** knob to select the next setting.

Low-Scale S-1 Adjustment (S1)

- Press the [V/M] key.
- Adjust the generator level to -7 dB μ (leaving the modulation level unchanged), then press the [F/W] key.
- Press the [F/W] key again, then press the [V/M] key.
- Rotate the **DIAL** knob to select the next setting.

S-Meter Full-Scale Adjustment (S9)

- Press the [V/M] key.
- Adjust the generator level to $+20$ dB μ (leaving the modulation level unchanged), then press the [F/W] key.
- Press the [F/W] key again, then press the [V/M] key.
- Rotate the **DIAL** knob to select the next setting.

Wide FM Low-Scale S-1 Adjustment (S1)

- Press the [V/M] key.
- Adjust the generator level to 0 dB μ (1 kHz tone @ ± 20 kHz deviation), then press the [F/W] key.
- Press the [F/W] key again, then press the [V/M] key.
- Rotate the **DIAL** knob to select the next setting.

Wide FM S-Meter Full-Scale Adjustment (S9)

- Press the [V/M] key.
- Adjust the generator level to +20dB μ (leaving the modulation level unchanged from the previous step), then press the [F/W] key.
- Press the [F/W] key again, then press the [V/M] key.
- Rotate the **DIAL** knob to select the next setting.

TX High Power (Low Band Edge @6.0 V) Adjustment (HHP)

- Set the DC power supply voltage to 6.0 V.
- Press the [V/M] key.
- Transmit, and adjust the output power level for 3.0 W (± 0.2 W) by rotating the **DIAL** knob, then press the [V/M] key.
- Rotate the **DIAL** knob to select the next setting.

TX High Power (Low Band Edge @4.4 V) Adjustment (LHP)

- Set the DC power supply voltage to 4.4 V.
- Press the [V/M] key.
- Transmit, and adjust the output power level for 1.5 W (± 0.1 W) by rotating the **DIAL** knob, then press the [V/M] key.
- Rotate the **DIAL** knob to select the next setting.

TX Low Power (Low Band Edge) Adjustment (LP)

- Press the [V/M] key.
- Transmit, and adjust the output power level for 0.1 W (± 0.05 W) by rotating the **DIAL** knob, then press the [V/M] key.
- Rotate the **DIAL** knob to select the next setting.

TX Deviation (Low Band Edge) Adjustment (dEV)

- Press the [V/M] key.
- Inject a 1 kHz audio tone at a level of 50 mV (rms) to the **MIC** jack, then press the [F/W] key.
- Transmit, and adjust the deviation for ± 4.2 kHz (± 0.2 kHz) by rotating the **DIAL** knob, then press the [V/M] key.
- Rotate the **DIAL** knob to select the next setting.

CTCSS Tone (67.0 Hz) Deviation (Low Band Edge)

Adjustment (670)

- Press the [V/M] key.
- Transmit, and adjust the deviation for ± 0.6 kHz (± 0.05 kHz) by rotating the **DIAL** knob, then press the [V/M] key.
- Rotate the **DIAL** knob to select the next setting.

CTCSS Tone (123.0 Hz) Deviation (Low Band Edge)

Adjustment (123)

- Press the [V/M] key.
- Transmit, and adjust the deviation for ± 0.6 kHz (± 0.05 kHz) by rotating the **DIAL** knob, then press the [V/M] key.
- Rotate the **DIAL** knob to select the next setting.

CTCSS Tone (254.1 Hz) Deviation (Low Band Edge)

Adjustment (254)

- Press the [V/M] key.
- Transmit, and adjust the deviation for ± 0.6 kHz (± 0.05 kHz) by rotating the **DIAL** knob, then press the [V/M] key.
- Rotate the **DIAL** knob to select the next setting.

DCS Tone Deviation (Low Band Edge) Adjustment (dCS)

- Press the [V/M] key.
- Transmit, and adjust the deviation for ± 0.6 kHz (± 0.05 kHz) by rotating the **DIAL** knob, then press the [V/M] key.
- Rotate the **DIAL** knob to select the Menu Item "HHP," then press the [F/W] key.

TX High Power (High Band Edge @6.0 V) Adjustment (HHP)

- Set the DC power supply voltage to 6.0 V.
- Press the [V/M] key.
- Transmit, and adjust the output power level for 3.0 W (± 0.2 W) by rotating the **DIAL** knob, then press the [V/M] key.
- Rotate the **DIAL** knob to select the next setting.

TX High Power (High Band Edge @4.4 V) Adjustment (LHP)

- Set the DC power supply voltage to 4.4 V.
- Press the [V/M] key.
- Transmit, and adjust the output power level for 1.5 W (± 0.1 W) by rotating the **DIAL** knob, then press the [V/M] key.
- Rotate the **DIAL** knob to select the next setting.

TX Low Power (High Band Edge) Adjustment (LP)

- Press the [V/M] key.
- Transmit, and adjust the output power level for 0.1 W (± 0.05 W) by rotating the **DIAL** knob, then press the [V/M] key.
- Rotate the **DIAL** knob to select the next setting.

Alignment

TX Deviation (High Band Edge) Adjustment (dEV)

- Press the [V/M] key.
- Inject a 1 kHz audio tone at a level of 50 mV (rms) to the **MIC** jack, then press the [F/W] key.
- Transmit, and adjust the deviation for 4.2 kHz (± 0.2 kHz) by rotating the **DIAL** knob, then press the [V/M] key.
- Rotate the **DIAL** knob to select the next setting.

CTCSS Tone (67.0 Hz) Deviation (High Band Edge) Adjustment (670)

- Press the [V/M] key.
- Transmit, and adjust the deviation for ± 0.6 kHz (± 0.05 kHz) by rotating the **DIAL** knob, then press the [V/M] key.
- Rotate the **DIAL** knob to select the next setting.

CTCSS Tone (123.0 Hz) Deviation (High Band Edge) Adjustment (123)

- Press the [V/M] key.
- Transmit, and adjust the deviation for ± 0.6 kHz (± 0.05 kHz) by rotating the **DIAL** knob, then press the [V/M] key.
- Rotate the **DIAL** knob to select the next setting.

CTCSS Tone (254.1 Hz) Deviation (High Band Edge) Adjustment (254)

- Press the [V/M] key.
- Transmit, and adjust the deviation for ± 0.6 kHz (± 0.05 kHz) by rotating the **DIAL** knob, then press the [V/M] key.
- Rotate the **DIAL** knob to select the next setting.

DCS Tone Deviation (High Band Edge) Adjustment (dCS)

- Press the [V/M] key.
- Transmit, and adjust the deviation for ± 0.6 kHz (± 0.05 kHz) by rotating the **DIAL** knob, then press the [V/M] key.

This completes the internal alignment routine for all bands. To save all settings and exit, press the [HM/RV] key.

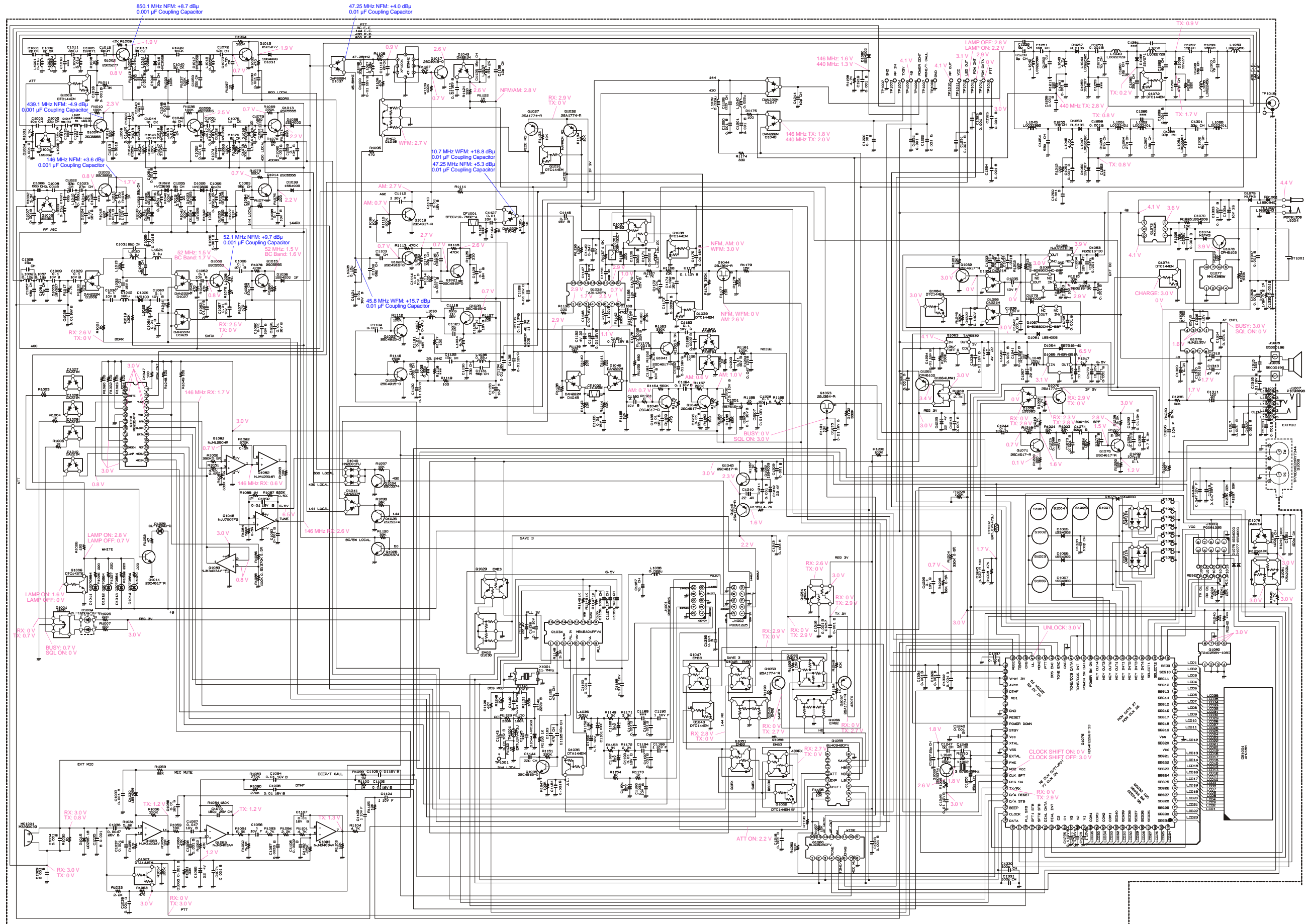

MAIN Unit

Parts Layout (Side A)

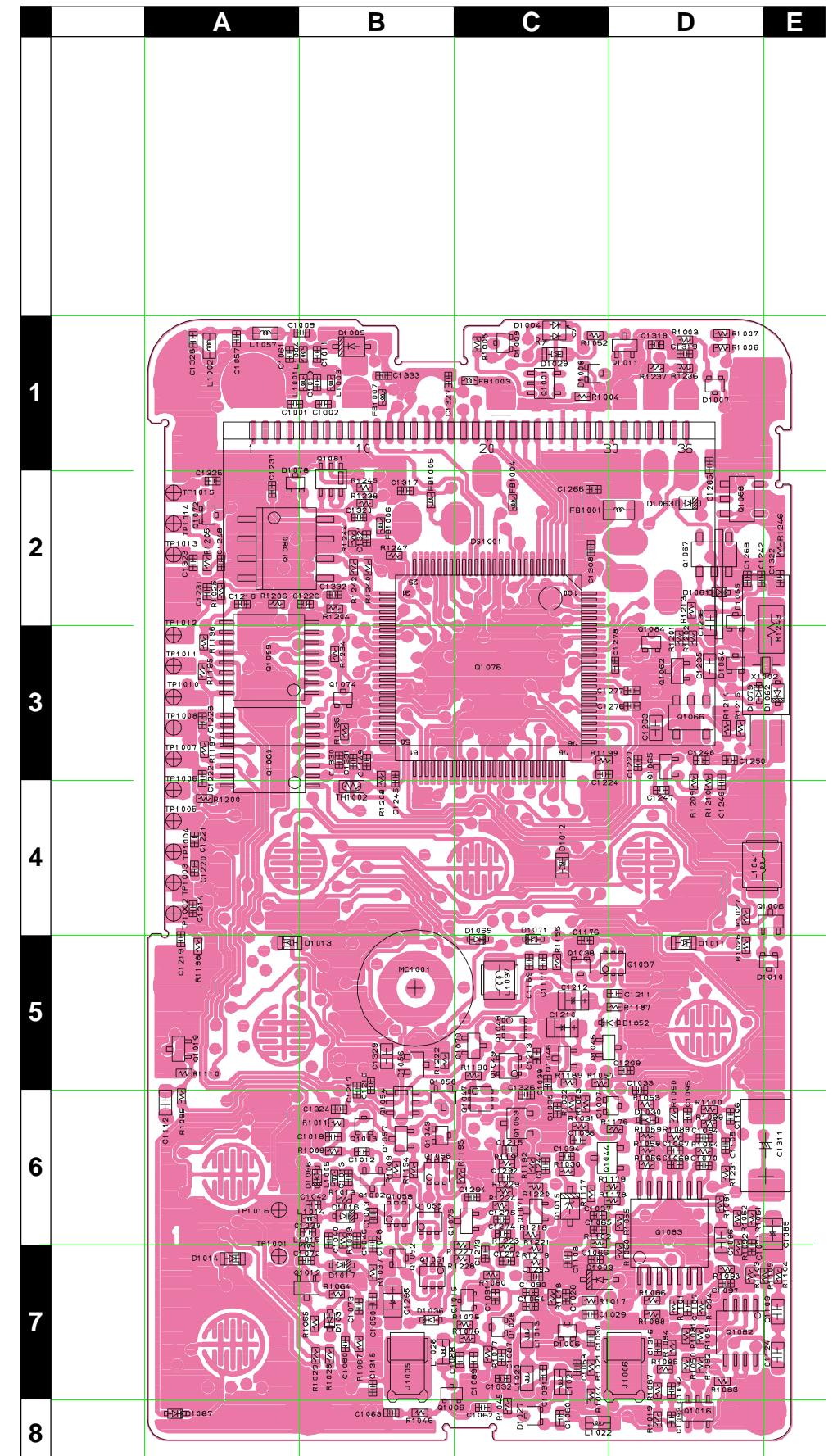
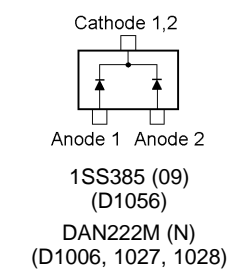
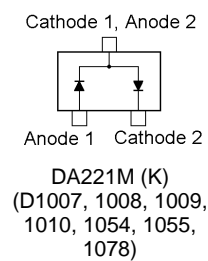
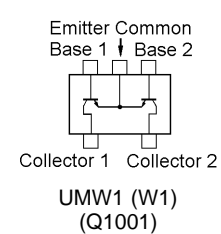
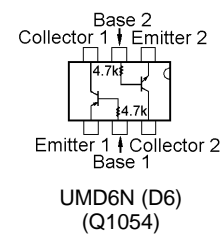
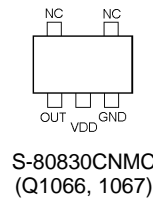
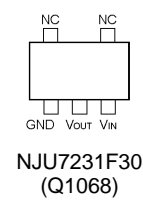
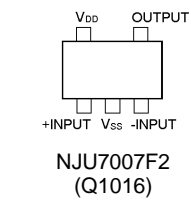
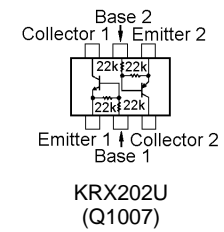
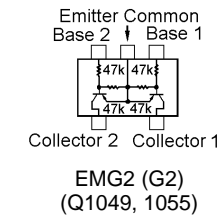
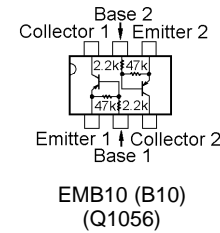
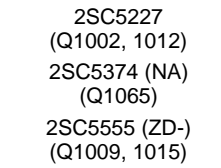
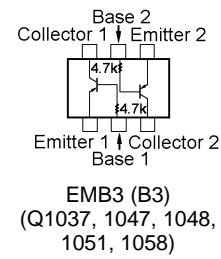
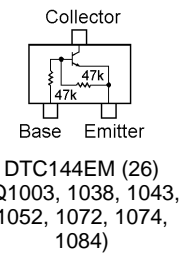
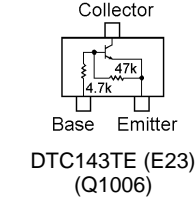
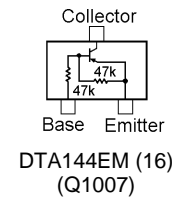
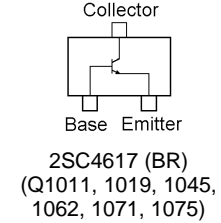
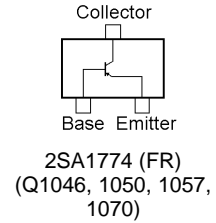
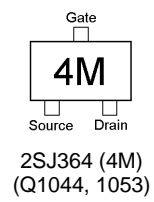
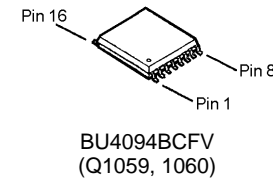
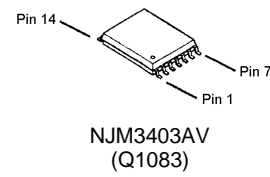
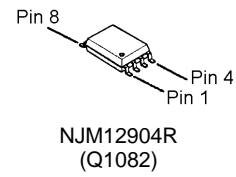
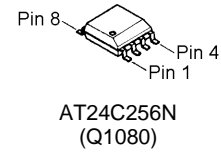
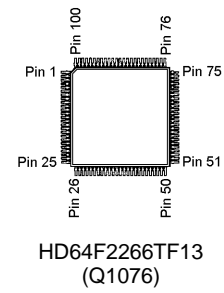

MAIN Unit

Parts Layout (Side B)

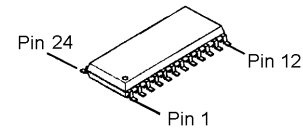
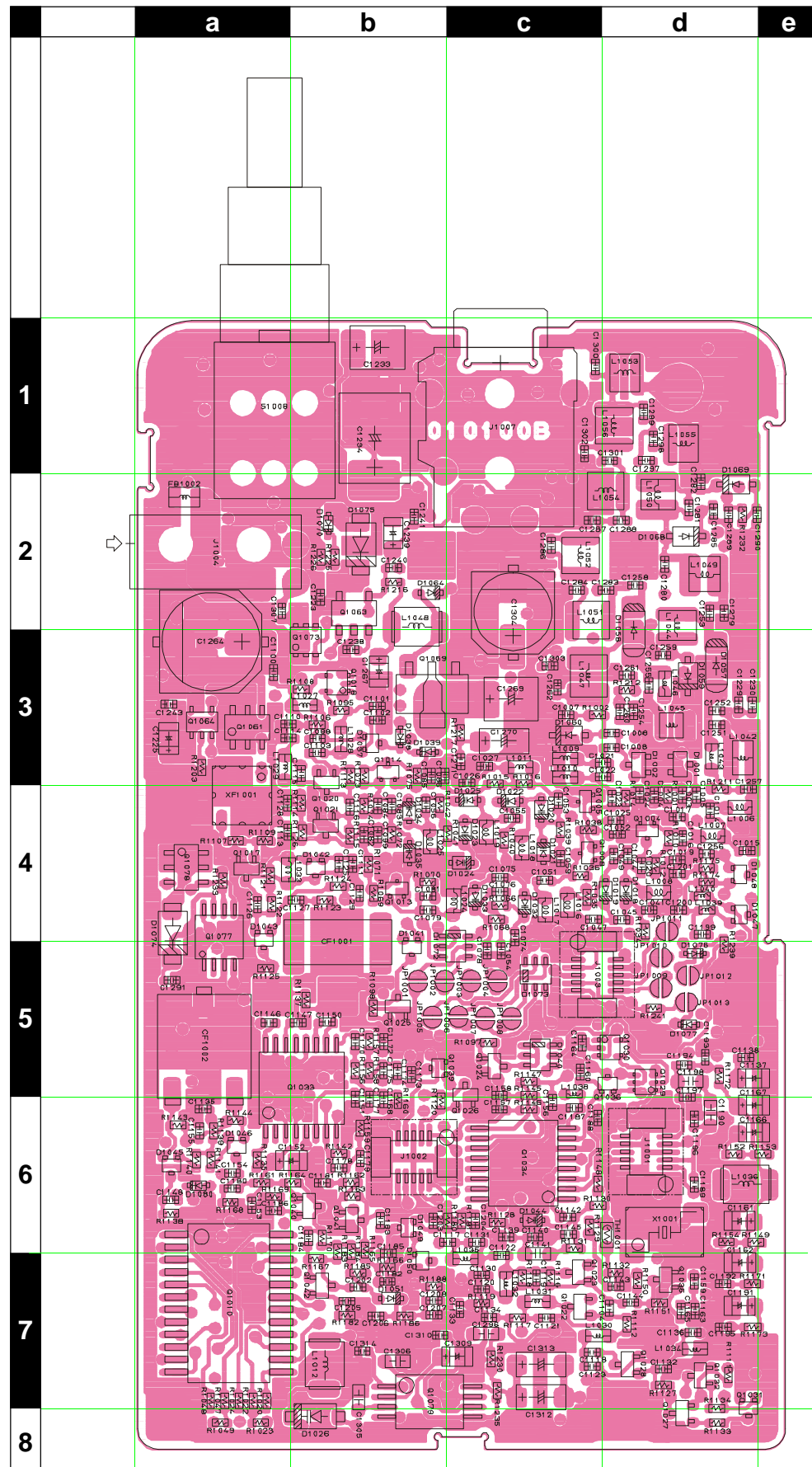

M62364FP
(Q1010)

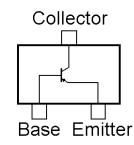

2SA1774 (FR)
(Q1027, 1032)

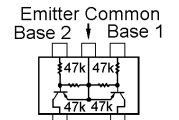

EMG2 (G2)
(Q1018, 1030)

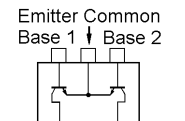

UMW1 (W1)
(Q1064)

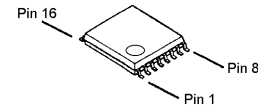

MB15A01PFV1
(Q1034)
TA31136FN
(Q1033)

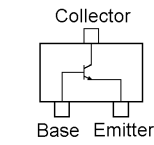

2SC4617 (BR)
(Q1040, 1041, 1042)
2SC4915 (QY)
(Q1017, 1020, 1021,
1022, 1023, 1028,
1035)

2SC5374 (NA)
(Q1024, 1025, 1026)
2SC5555 (ZD-)
(Q1004, 1005, 1008,
1013, 1014)

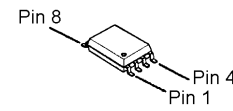

MM1438BWLE
(Q1077)
NJM2135V
(Q1079)

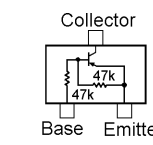

DTA144EM (16)
(Q1036)

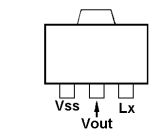

RH5RH651
(Q1069)

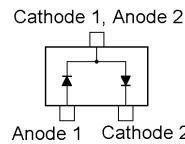

1SS3621 (C3)
(Q1001, 1002)
DA221M (K)
(D1042, 1049, 1050)

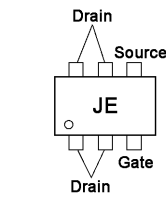

MCH6305 (JE)
(Q1073)

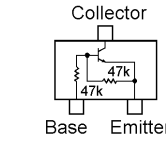

DTC144EM (26)
(Q1031, 1039)

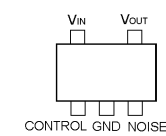

TAR5S30
(Q1063)

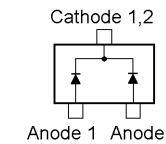

DAN222M (N)
(D1041, 1043, 1045,
1046, 1047, 1048)
DAP222M
(D1037)

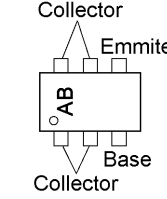

CPH6102 (AB)
(Q1061, 1078)

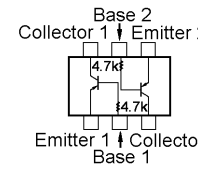

EMB3 (B3)
(Q1029)

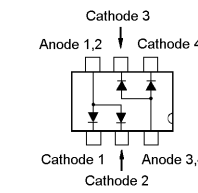

UMP11N (P11)
(D1072, 1073)

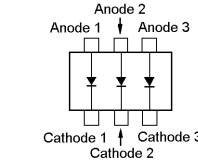

HN2D01FU (A1)
(D1040)

MAIN Unit

Parts List

REF	DESCRIPTION	VALUE	V/W	TOL.	MFR'S DESIG	VXSTD P/N	VERS.	LOT	SIDE	LAY ADR
C 1073	CHIP CAP.	0.5pF	50V	CK	UMK105CK0R5CW-F	K22178247		1-	A	B7
C 1074	CHIP CAP.	33pF	50V	CH	UMK105CH330JW-F	K22178270		1-	B	c4
C 1075	CHIP CAP.	1pF	50V	CK	UMK105CK010CW-F	K22178248		1-	B	c4
C 1076	CHIP CAP.	2pF	50V	CK	UMK105CK020CW-F	K22178250		1-	B	c4
C 1078	CHIP CAP.	33pF	50V	CH	UMK105CH330JW-F	K22178270		1-	B	c5
C 1079	CHIP CAP.	22pF	50V	CH	UMK105CH220JW-F	K22178266		1-	B	b4
C 1080	CHIP CAP.	0.001uF	50V	B	UMK105B102KW-F	K22178829		1-	A	B7
C 1081	CHIP CAP.	3pF	50V	CJ	UMK105CJ030CW-F	K22178251		1-	B	b4
C 1082	CHIP CAP.	0.001uF	50V	B	UMK105B102KW-F	K22178829		1-	B	b4
C 1083	CHIP CAP.	56pF	50V	CH	UMK105CH560JW-F	K22178276		1-	B	b4
C 1084	CHIP CAP.	2pF	50V	CK	UMK105CK020CW-F	K22178250		1-	B	b4
C 1085	CHIP CAP.	0.1uF	10V	B	GRM36B104K10PT	K22108802		1-	B	b3
C 1086	CHIP CAP.	0.001uF	50V	B	UMK105B102KW-F	K22178829		1-	B	b3
C 1087	CHIP CAP.	0.01uF	16V	B	GRM36B103K16PT	K22128804		1-	A	C7
C 1088	CHIP CAP.	0.1uF	10V	B	GRM36B104K10PT	K22108802		1-	A	C7
C 1089	CHIP CAP.	10pF	50V	CH	UMK105CH100DW-F	K22178258		1-	A	C7
C 1090	CHIP CAP.	0.01uF	16V	B	GRM36B103K16PT	K22128804		1-	A	C7
C 1091	CHIP CAP.	0.01uF	16V	B	GRM36B103K16PT	K22128804		1-	A	C7
C 1092	CHIP CAP.	0.01uF	16V	B	GRM36B103K16PT	K22128804		1-	A	D7
C 1093	CHIP CAP.	0.001uF	50V	B	UMK105B102KW-F	K22178829		1-	A	D8
C 1094	CHIP CAP.	0.01uF	16V	B	GRM36B103K16PT	K22128804		1-	A	D6
C 1095	CHIP CAP.	0.01uF	16V	B	GRM36B103K16PT	K22128804		1-	A	D6
C 1096	CHIP CAP.	1uF	10V	F	GRM39F105Z10PT	K22105001		1-	A	D6
C 1097	CHIP CAP.	0.0033uF	50V	B	GRM36B332K50PT	K22178815		1-	A	D7
C 1098	CHIP CAP.	33pF	50V	CH	UMK105CH330JW-F	K22178270		1-	B	b3
C 1099	CHIP CAP.	0.1uF	10V	B	GRM36B104K10PT	K22108802		1-	B	b4
C 1100	CHIP CAP.	0.01uF	16V	B	GRM36B103K16PT	K22128804		1-	B	a3
C 1101	CHIP CAP.	0.01uF	16V	B	GRM36B103K16PT	K22128804		1-	B	b3
C 1102	CHIP CAP.	68pF	50V	CH	UMK105CH680JW-F	K22178278		1-	B	b3
C 1103	CHIP CAP.	5pF	50V	CH	UMK105CH050CW-F	K22178253		1-	B	b3
C 1104	CHIP CAP.	0.001uF	50V	B	UMK105B102KW-F	K22178829		1-	B	d7
C 1105	CHIP CAP.	0.01uF	16V	B	GRM36B103K16PT	K22128804		1-	A	D6
C 1106	CHIP CAP.	0.01uF	16V	B	GRM36B103K16PT	K22128804		1-	A	D6
C 1107	CHIP CAP.	0.01uF	16V	B	GRM36B103K16PT	K22128804		1-	A	D7
C 1108	CHIP CAP.	0.0022uF	50V	B	UMK105B222KW-F	K22178833		1-	A	C7
C 1109	CHIP CAP.	1uF	10V	F	GRM39F105Z10PT	K22105001		1-	A	E7
C 1110	CHIP CAP.	2pF	50V	CK	UMK105CK020CW-F	K22178250		1-	B	a3
C 1111	CHIP CAP.	0.01uF	16V	B	GRM36B103K16PT	K22128804		1-	B	b4
C 1112	CHIP CAP.	1uF	10V	F	GRM39F105Z10PT	K22105001		1-	A	A6
C 1113	CHIP CAP.	0.01uF	16V	B	GRM36B103K16PT	K22128804		1-	B	a4
C 1114	CHIP CAP.	0.01uF	16V	B	GRM36B103K16PT	K22128804		1-	B	a3
C 1115	CHIP CAP.	22pF	50V	CH	UMK105CH220JW-F	K22178266		1-	B	b3
C 1116	CHIP CAP.	100pF	50V	CH	UMK105CH101JW-F	K22178282		1-	B	b4
C 1117	CHIP CAP.	0.001uF	50V	B	UMK105B102KW-F	K22178829		1-	B	b6
C 1118	CHIP CAP.	180pF	25V	CH	GRM36CH181J25PT	K22148201		1-	B	c7
C 1119	CHIP CAP.	100pF	50V	CH	UMK105CH101JW-F	K22178282		1-	B	c7
C 1120	CHIP CAP.	0.01uF	16V	B	GRM36B103K16PT	K22128804		1-	B	c7
C 1121	CHIP CAP.	0.01uF	16V	B	GRM36B103K16PT	K22128804		1-	B	c7
C 1122	CHIP CAP.	10pF	50V	CH	UMK105CH100DW-F	K22178258		1-	B	c6
C 1123	CHIP CAP.	5pF	50V	CH	UMK105CH050CW-F	K22178253		1-	B	c7
C 1124	CHIP CAP.	1uF	10V	F	GRM39F105Z10PT	K22105001		1-	A	E7
C 1125	CHIP CAP.	15pF	50V	CH	UMK105CH150JW-F	K22178262		1-	B	b4
C 1126	CHIP CAP.	10pF	50V	CH	UMK105CH100DW-F	K22178258		1-	B	a4
C 1127	CHIP CAP.	0.01uF	16V	B	GRM36B103K16PT	K22128804		1-	B	b4
C 1128	CHIP CAP.	0.01uF	16V	B	GRM36B103K16PT	K22128804		1-	B	a4
C 1129	CHIP CAP.	0.01uF	16V	B	GRM36B103K16PT	K22128804		1-	B	b4
C 1130	CHIP CAP.	33pF	50V	CH	UMK105CH330JW-F	K22178270		1-	B	c7
C 1131	CHIP CAP.	56pF	50V	CH	UMK105CH560JW-F	K22178276		1-	B	c6
C 1132	CHIP CAP.	0.01uF	16V	B	GRM36B103K16PT	K22128804		1-	B	d7
C 1133	CHIP CAP.	0.01uF	16V	B	GRM36B103K16PT	K22128804		1-	B	c7
C 1134	CHIP CAP.	0.01uF	16V	B	GRM36B103K16PT	K22128804		1-	B	c7
C 1135	CHIP CAP.	0.01uF	16V	B	GRM36B103K16PT	K22128804		1-	B	a6
C 1136	CHIP CAP.	0.01uF	16V	B	GRM36B103K16PT	K22128804		1-	B	d7
C 1137	CHIP TA.CAP.	22uF	4V		TESVSP0G226M-8R	K78060047		1-	B	d5
C 1138	CHIP CAP.	0.1uF	10V	B	GRM36B104K10PT	K22108802		1-	B	d5
C 1140	CHIP CAP.	0.01uF	16V	B	GRM36B103K16PT	K22128804		1-	B	c6
C 1141	CHIP CAP.	1uF	10V	F	GRM39F105Z10PT	K22105001		1-	B	c6
C 1142	CHIP CAP.	220pF	50V	B	UMK105B221KW-F	K22178821		1-	B	c6
C 1143	CHIP CAP.	0.01uF	16V	B	GRM36B103K16PT	K22128804		1-	B	d7
C 1144	CHIP CAP.	22pF	50V	CH	UMK105CH220JW-F	K22178266		1-	B	d7
C 1146	CHIP CAP.	0.01uF	16V	B	GRM36B103K16PT	K22128804		1-	B	a5
C 1147	CHIP CAP.	0.01uF	16V	B	GRM36B103K16PT	K22128804		1-	B	b5
C 1148	CHIP CAP.	0.01uF	16V	B	GRM36B103K16PT	K22128804		1-	B	a6

MAIN Unit

Parts List

REF	DESCRIPTION	VALUE	V/W	TOL.	MFR'S DESIG	VXSTD P/N	VERS.	LOT	SIDE	LAY ADR
C 1149	CHIP CAP.	0.047uF	10V	B	GRM36B473K10PT	K22108801		1-	A	B3
C 1150	CHIP CAP.	100pF	50V	CH	UMK105CH101JW-F	K22178282		1-	B	b5
C 1151	CHIP CAP.	0.1uF	10V	B	GRM36B104K10PT	K22108802		1-	B	b5
C 1152	CHIP TA.CAP.	22uF	4V		TESVSP0G226M-8R	K78060047		1-	B	a6
C 1153	CHIP CAP.	0.01uF	16V	B	GRM36B103K16PT	K22128804		1-	B	a6
C 1154	CHIP CAP.	0.01uF	16V	B	GRM36B103K16PT	K22128804		1-	B	a6
C 1155	CHIP CAP.	0.01uF	16V	B	GRM36B103K16PT	K22128804		1-	B	a6
C 1156	CHIP CAP.	100pF	50V	CH	UMK105CH101JW-F	K22178282		1-	B	c6
C 1157	CHIP CAP.	100pF	50V	CH	UMK105CH101JW-F	K22178282		1-	B	c6
C 1158	CHIP CAP.	100pF	50V	CH	UMK105CH101JW-F	K22178282		1-	B	c5
C 1159	CHIP CAP.	47pF	50V	CH	UMK105CH470JW-F	K22178274		1-	B	d7
C 1160	CHIP CAP.	0.001uF	50V	B	UMK105B102KW-F	K22178829		1-	B	c5
C 1162	CHIP TA.CAP.	0.1uF	20V		SKF-1D104M-RP	K78130049		1-	B	d7
C 1163	CHIP CAP.	47pF	50V	CH	UMK105CH470JW-F	K22178274		1-	B	d7
C 1164	CHIP CAP.	0.001uF	50V	B	UMK105B102KW-F	K22178829		1-	B	c5
C 1165	CHIP CAP.	10pF	50V	CH	UMK105CH100DW-F	K22178258		1-	B	d7
C 1166	CHIP TA.CAP.	1.5uF	10V		TESVSP1A155M-8R	K78100050		1-	B	d6
C 1167	CHIP TA.CAP.	0.1uF	20V		SKF-1D104M-RP	K78130049		1-	B	d6
C 1168	CHIP CAP.	470pF	50V	B	UMK105B471KW-F	K22178825		1-	B	b5
C 1169	CHIP CAP.	330pF	50V	B	UMK105B331KW-F	K22178823		1-	A	C5
C 1170	CHIP CAP.	0.0047uF	25V	B	GRM36B472K25PT	K22148830		1-	B	b5
C 1171	CHIP CAP.	0.0022uF	50V	B	UMK105B222KW-F	K22178833		1-	A	C5
C 1172	CHIP CAP.	0.01uF	16V	B	GRM36B103K16PT	K22128804		1-	B	b5
C 1173	CHIP CAP.	0.0039uF	50V	B	UMK105B392KW-F	K22178836		1-	B	b5
C 1174	CHIP CAP.	0.022uF	16V	B	EMK105B223KW-F	K22128813		1-	B	b5
C 1175	CHIP CAP.	0.1uF	10V	B	GRM36B104K10PT	K22108802		1-	B	b5
C 1176	CHIP CAP.	0.01uF	16V	B	GRM36B103K16PT	K22128804		1-	A	C5
C 1177	CHIP CAP.	470pF	50V	B	UMK105B471KW-F	K22178825		1-	B	b5
C 1178	CHIP CAP.	0.0056uF	25V	B	GRM36B562K50PT	K22148802		1-	B	b6
C 1179	CHIP CAP.	0.001uF	50V	B	UMK105B102KW-F	K22178829		1-	B	b6
C 1180	CHIP CAP.	0.1uF	10V	B	GRM36B104K10PT	K22108802		1-	B	a6
C 1181	CHIP CAP.	0.1uF	10V	B	GRM36B104K10PT	K22108802		1-	B	b6
C 1182	CHIP CAP.	0.01uF	16V	B	GRM36B103K16PT	K22128804		1-	B	b7
C 1183	CHIP CAP.	0.1uF	10V	B	GRM36B104K10PT	K22108802		1-	B	b6
C 1184	CHIP CAP.	0.1uF	10V	B	GRM36B104K10PT	K22108802		1-	B	b6
C 1185	CHIP CAP.	0.0022uF	50V	B	UMK105B222KW-F	K22178833		1-	B	b6
C 1186	CHIP CAP.	0.01uF	16V	B	GRM36B103K16PT	K22128804		1-	B	a6
C 1187	CHIP CAP.	7pF	50V	CH	UMK105CH070DW-F	K22178255		1-	B	c6
C 1188	CHIP CAP.	0.01uF	16V	B	GRM36B103K16PT	K22128804		1-	B	c6
C 1190	CHIP CAP.	1uF	10V	F	GRM39F105Z10PT	K22105001		1-	B	d6
C 1191	CHIP TA.CAP.	0.1uF	20V		SKF-1D104M-RP	K78130049		1-	B	d7
C 1192	CHIP CAP.	0.001uF	50V	B	UMK105B102KW-F	K22178829		1-	B	d7
C 1193	CHIP CAP.	0.01uF	16V	B	GRM36B103K16PT	K22128804		1-	B	d5
C 1195	CHIP CAP.	0.033uF	10V	B	GRM36B333K10PT	K22108803		1-	B	d7
C 1196	CHIP CAP.	0.001uF	50V	B	UMK105B102KW-F	K22178829		1-	B	d6
C 1197	CHIP CAP.	0.001uF	50V	B	UMK105B102KW-F	K22178829		1-	B	d5
C 1198	CHIP CAP.	1uF	10V	F	GRM39F105Z10PT	K22105001		1-	B	d5
C 1199	CHIP CAP.	22pF	50V	CH	UMK105CH220JW-F	K22178266		1-	B	d4
C 1200	CHIP CAP.	0.001uF	50V	B	UMK105B102KW-F	K22178829		1-	B	d4
C 1201	CHIP CAP.	0.001uF	50V	B	UMK105B102KW-F	K22178829		1-	B	d4
C 1202	CHIP CAP.	0.1uF	10V	B	GRM36B104K10PT	K22108802		1-	B	b7
C 1203	CHIP CAP.	0.01uF	16V	B	GRM36B103K16PT	K22128804		1-	B	b6
C 1204	CHIP CAP.	0.047uF	10V	B	GRM36B473K10PT	K22108801		1-	B	c6
C 1205	CHIP CAP.	0.01uF	16V	B	GRM36B103K16PT	K22128804		1-	B	b7
C 1206	CHIP CAP.	0.1uF	10V	B	GRM36B104K10PT	K22108802		1-	B	b7
C 1207	CHIP CAP.	0.01uF	16V	B	GRM36B103K16PT	K22128804		1-	B	b7
C 1208	CHIP CAP.	0.1uF	10V	B	GRM36B104K10PT	K22108802		1-	B	b7
C 1209	CHIP CAP.	0.001uF	50V	B	UMK105B102KW-F	K22178829		1-	A	D5
C 1210	CHIP TA.CAP.	22uF	4V		TESVSP0G226M-8R	K78060047		1-	A	C5
C 1211	CHIP CAP.	0.001uF	50V	B	UMK105B102KW-F	K22178829		1-	A	D5
C 1212	CHIP TA.CAP.	22uF	4V		TESVSP0G226M-8R	K78060047		1-	A	C5
C 1213	CHIP CAP.	0.001uF	50V	B	UMK105B102KW-F	K22178829		1-	A	C5
C 1214	CHIP CAP.	10pF	50V	CH	UMK105CH100DW-F	K22178258		1-	A	A4
C 1215	CHIP CAP.	0.01uF	16V	B	GRM36B103K16PT	K22128804		1-	A	C6
C 1216	CHIP CAP.	0.001uF	50V	B	UMK105B102KW-F	K22178829		1-	A	B5
C 1217	CHIP CAP.	0.001uF	50V	B	UMK105B102KW-F	K22178829		1-	A	B5
C 1218	CHIP CAP.	0.001uF	50V	B	UMK105B102KW-F	K22178829		1-	A	A2
C 1219	CHIP CAP.	0.001uF	50V	B	UMK105B102KW-F	K22178829		1-	A	A5
C 1220	CHIP CAP.	0.001uF	50V	B	UMK105B102KW-F	K22178829		1-	A	A4
C 1221	CHIP CAP.	0.001uF	50V	B	UMK105B102KW-F	K22178829		1-	A	A4
C 1222	CHIP CAP.	0.001uF	50V	B	UMK105B102KW-F	K22178829		1-	A	A3
C 1223	CHIP CAP.	0.001uF	50V	B	UMK105B102KW-F	K22178829		1-	B	b2
C 1224	CHIP CAP.	0.01uF	16V	B	GRM36B103K16PT	K22128804		1-	A	C3

MAIN Unit

Parts List

REF	DESCRIPTION	VALUE	V/W	TOL.	MFR'S DESIG	VXSTD P/N	VERS.	LOT	SIDE	LAY ADR
C 1225	CHIP TA.CAP.	22uF	4V		TESVSP0G226M-8R	K78060047		1-	B	a3
C 1226	CHIP CAP.	0.1uF	10V	B	GRM36B104K10PT	K22108802		1-	A	B2
C 1227	CHIP CAP.	15pF	50V	CH	GRM36CH150J50PT	K22178216		1-	A	D3
C 1228	CHIP CAP.	0.001uF	50V	B	UMK105B102KW-F	K22178829		1-	A	A3
C 1229	CHIP CAP.	9pF	50V	CH	UMK105CH090DW-F	K22178257		1-	B	d3
C 1230	CHIP CAP.	9pF	50V	CH	UMK105CH090DW-F	K22178257		1-	B	d3
C 1231	CHIP CAP.	0.001uF	50V	B	UMK105B102KW-F	K22178829		1-	A	A2
C 1233	CHIP TA.CAP.	68uF			TEMSVB20G686M-8R	K78060033		1-	B	b1
C 1234	CHIP TA.CAP.	220uF	4V		SK4-0G227M-RD	K78060014		1-	B	b1
C 1235	CHIP CAP.	1uF	10V	F	GRM39F105Z10PT	K22105001		1-	A	D3
C 1236	CHIP CAP.	1uF	10V	F	GRM39F105Z10PT	K22105001		1-	A	D2
C 1237	CHIP CAP.	0.001uF	50V	B	UMK105B102KW-F	K22178829		1-	A	A2
C 1238	CHIP CAP.	0.01uF	16V	B	GRM36B103K16PT	K22128804		1-	B	b3
C 1239	CHIP TA.CAP.	22uF	4V		TESVSP0G226M-8R	K78060047		1-	B	b2
C 1240	CHIP CAP.	0.001uF	50V	B	UMK105B102KW-F	K22178829		1-	B	b2
C 1241	CHIP CAP.	0.01uF	16V	B	GRM36B103K16PT	K22128804		1-	B	b2
C 1242	CHIP CAP.	0.001uF	50V	B	UMK105B102KW-F	K22178829		1-	A	D2
C 1243	CHIP CAP.	0.001uF	50V	B	UMK105B102KW-F	K22178829		1-	B	a3
C 1244	CHIP CAP.	0.1uF	10V	B	GRM36B104K10PT	K22108802		1-	A	C6
C 1245	CHIP CAP.	0.047uF	10V	B	GRM36B473K10PT	K22108801		1-	A	B3
C 1246	CHIP CAP.	0.01uF	16V	B	GRM36B103K16PT	K22128804		1-	A	D3
C 1247	CHIP CAP.	5pF	50V	CH	UMK105CH050CW-F	K22178253		1-	A	D4
C 1248	CHIP CAP.	0.001uF	50V	B	UMK105B102KW-F	K22178829		1-	A	A2
C 1249	CHIP CAP.	2pF	50V	CK	UMK105CK020CW-F	K22178250		1-	A	D3
C 1250	CHIP CAP.	15pF	50V	CH	GRM36CH150J50PT	K22178216		1-	A	D3
C 1251	CHIP CAP.	15pF	50V	CH	UMK105CH150JW-F	K22178262		1-	B	d3
C 1252	CHIP CAP.	3pF	50V	CJ	UMK105CJ030CW-F	K22178251		1-	B	d3
C 1253	CHIP CAP.	0.001uF	50V	B	UMK105B102KW-F	K22178829		1-	B	d2
C 1254	CHIP CAP.	68pF	50V	CH	UMK105CH680JW-F	K22178278		1-	B	d3
C 1255	CHIP CAP.	39pF	50V	CH	UMK105CH390JW-F	K22178272		1-	B	d3
C 1256	CHIP CAP.	0.001uF	50V	B	UMK105B102KW-F	K22178829		1-	B	d4
C 1257	CHIP CAP.	0.001uF	50V	B	UMK105B102KW-F	K22178829		1-	B	d4
C 1258	CHIP CAP.	0.001uF	50V	B	UMK105B102KW-F	K22178829		1-	B	d2
C 1260	CHIP CAP.	0.001uF	50V	B	UMK105B102KW-F	K22178829		1-	B	d3
C 1261	CHIP CAP.	0.001uF	50V	B	UMK105B102KW-F	K22178829		1-	B	d3
C 1263	CHIP CAP.	1uF	10V	F	GRM39F105Z10PT	K22105001		1-	A	D3
C 1264	AL.ELECTRO.CAP.	47uF	16V		RV4-16V470MF46-RR2	K48120019		1-	B	a3
C 1265	CHIP CAP.	0.001uF	50V	B	UMK105B102KW-F	K22178829		1-	A	D1
C 1266	CHIP CAP.	0.001uF	50V	B	UMK105B102KW-F	K22178829		1-	A	C2
C 1267	CHIP TA.CAP.	22uF	4V		TESVSP0G226M-8R	K78060047		1-	B	b3
C 1268	CHIP CAP.	0.001uF	50V	B	UMK105B102KW-F	K22178829		1-	A	D2
C 1269	CHIP TA.CAP.	33uF	10V		TEMSVB21A336M-8R	K78100047		1-	B	c3
C 1270	CHIP TA.CAP.	10uF	10V		TEMSVA1A106M-8R	K78100028		1-	B	c3
C 1271	CHIP CAP.	0.001uF	50V	B	UMK105B102KW-F	K22178829		1-	B	c3
C 1272	CHIP CAP.	0.0068uF	25V	B	GRM36B682J25PT	K22148803		1-	A	C7
C 1273	CHIP CAP.	0.001uF	50V	B	UMK105B102KW-F	K22178829		1-	A	C7
C 1274	CHIP CAP.	820pF	50V	B	GRM36B821K50PT	K22178808		1-	A	C6
C 1275	CHIP CAP.	820pF	50V	B	GRM36B821K50PT	K22178808		1-	A	C6
C 1276	CHIP CAP.	0.1uF	10V	B	GRM36B104K10PT	K22108802		1-	A	D3
C 1277	CHIP CAP.	0.1uF	10V	B	GRM36B104K10PT	K22108802		1-	A	D3
C 1278	CHIP CAP.	0.1uF	10V	B	GRM36B104K10PT	K22108802		1-	A	D3
C 1279	CHIP CAP.	7pF	50V	CH	UMK105CH070DW-F	K22178255		1-	B	d2
C 1280	CHIP CAP.	12pF	50V	CH	UMK105CH120JW-F	K22178260		1-	B	d2
C 1282	CHIP CAP.	8pF	50V	CH	UMK105CH080DW-F	K22178256		1-	B	d2
C 1283	CHIP CAP.	27pF	50V	CH	UMK105CH270JW-F	K22178268		1-	B	d2
C 1284	CHIP CAP.	27pF	50V	CH	UMK105CH270JW-F	K22178268		1-	B	c2
C 1285	CHIP CAP.	39pF	50V	CH	UMK105CH390JW-F	K22178272		1-	B	d2
C 1287	CHIP CAP.	15pF	50V	CH	UMK105CH150JW-F	K22178262		1-	B	c2
C 1288	CHIP CAP.	33pF	50V	CH	UMK105CH330JW-F	K22178270		1-	B	d2
C 1289	CHIP CAP.	0.001uF	50V	B	UMK105B102KW-F	K22178829		1-	B	d2
C 1290	CHIP CAP.	47pF	50V	CH	UMK105CH470JW-F	K22178274		1-	B	d2
C 1291	CHIP CAP.	0.001uF	50V	B	UMK105B102KW-F	K22178829		1-	B	a5
C 1292	CHIP CAP.	0.1uF	10V	B	GRM36B104K10PT	K22108802		1-	A	C6
C 1293	CHIP CAP.	0.01uF	16V	B	GRM36B103K16PT	K22128804		1-	A	C7
C 1294	CHIP CAP.	0.001uF	50V	B	UMK105B102KW-F	K22178829		1-	A	C6
C 1295	CHIP TA.CAP.	4.7uF	6.3V		TESVSP0J475M-8R	K78080053		1-	A	B7
C 1296	CHIP CAP.	1uF	10V	F	GRM39F105Z10PT	K22105001		1-	B	c7
C 1297	CHIP CAP.	15pF	50V	CH	UMK105CH150JW-F	K22178262		1-	B	d1
C 1298	CHIP CAP.	18pF	50V	CH	UMK105CH180JW-F	K22178264		1-	B	d1
C 1299	CHIP CAP.	15pF	50V	CH	UMK105CH150JW-F	K22178262		1-	B	d1
C 1300	CHIP CAP.	7pF	50V	CH	UMK105CH070DW-F	K22178255		1-	B	c1
C 1301	CHIP CAP.	33pF	50V	CH	UMK105CH330JW-F	K22178270		1-	B	d1
C 1302	CHIP CAP.	8pF	50V	CH	UMK105CH080DW-F	K22178256		1-	B	c1

MAIN Unit

Parts List

REF	DESCRIPTION	VALUE	V/W	TOL.	MFR'S DESIG	VXSTD P/N	VERS.	LOT	SIDE	LAY ADR
C 1303	CHIP CAP.	0.01uF	16V	B	GRM36B103K16PT	K22128804		1-	B	c3
C 1304	AL.ELECTRO.CAP.		10V		RV4-10V330ME46-R	K48100005		1-	B	c2
C 1305	CHIP CAP.	0.022uF	25V	B	GRM39B223K25PT	K22144807		1-	B	b7
C 1306	CHIP CAP.	1uF	10V	F	GRM39F105Z10PT	K22105001		1-	B	b7
C 1307	CHIP CAP.	0.001uF	50V	B	UMK105B102KW-F	K22178829		1-	B	a2
C 1308	CHIP CAP.	0.001uF	50V	B	UMK105B102KW-F	K22178829		1-	A	C2
C 1309	CHIP TA.CAP.	1uF	6.3V		TESVSP0J105M-8R	K78080028		1-	B	c7
C 1310	CHIP CAP.	0.001uF	50V	B	UMK105B102KW-F	K22178829		1-	B	b7
C 1311	CHIP TA.CAP.	100uF	4V		TEMSVCOG107M12R	K78060021		1-	A	D6
C 1312	CHIP TA.CAP.	47uF	4V		SK7-0G476M-RA	K78060048		1-	B	c7
C 1313	CHIP TA.CAP.	47uF	4V		SK7-0G476M-RA	K78060048		1-	B	c7
C 1314	CHIP CAP.	0.001uF	50V	B	UMK105B102KW-F	K22178829		1-	B	b7
C 1316	CHIP CAP.	0.01uF	16V	B	GRM36B103K16PT	K22128804		1-	A	D7
C 1317	CHIP CAP.	0.001uF	50V	B	UMK105B102KW-F	K22178829		1-	A	B2
C 1318	CHIP CAP.	0.047uF	16V	F	GRM36F473Z16PT	K22129004		1-	A	D1
C 1319	CHIP CAP.	0.047uF	16V	F	GRM36F473Z16PT	K22129004		1-	A	D1
C 1320	CHIP CAP.	100pF	50V	CH	GRM36CH101J50PT	K22178236		1-	A	B2
C 1321	CHIP CAP.	100pF	50V	CH	GRM36CH101J50PT	K22178236		1-	A	B2
C 1322	CHIP CAP.	0.1uF	10V	B	GRM36B104K10PT	K22108802		1-	A	E2
C 1323	CHIP CAP.	0.001uF	50V	B	UMK105B102KW-F	K22178829		1-	A	A2
C 1324	CHIP CAP.	0.001uF	50V	B	UMK105B102KW-F	K22178829		1-	A	B6
C 1325	CHIP CAP.	0.001uF	50V	B	UMK105B102KW-F	K22178829		1-	A	A2
C 1326	CHIP CAP.	0.001uF	50V	B	UMK105B102KW-F	K22178829		1-	A	C6
C 1327	CHIP CAP.	0.001uF	50V	B	UMK105B102KW-F	K22178829		1-	A	B1
C 1328	CHIP CAP.	15pF	50V	CH	UMK105CH150JW-F	K22178262		1-	A	A1
C 1329	CHIP CAP.	0.001uF	50V	B	GRM39B102M50PT	K22174809		1-	A	B5
C 1330	CHIP CAP.	100pF	50V	CH	UMK105CH101JW-F	K22178282		1-	A	B3
C 1331	CHIP CAP.	100pF	50V	CH	UMK105CH101JW-F	K22178282		1-	A	B3
C 1332	CHIP CAP.	0.001uF	50V	B	UMK105B102KW-F	K22178829		1-	A	B2
C 1333	CHIP CAP.	0.001uF	50V	B	UMK105B102KW-F	K22178829		1-	A	B1
C 1334	CERAMIC CAP.	0.001uF	50V	B	UP050B102K-A-B	K28179001		1-		
C 1335	CHIP CAP.	0.001uF	50V	B	UMK105B102KW-F	K22178829		1-		
C 1336	CHIP CAP.	0.001uF	50V	B	UMK105B102KW-F	K22178829		1-		
C 1337	CHIP CAP.	0.001uF	50V	B	GRM39B102M50PT	K22174809		1-		
C 1338	CHIP CAP.	100pF	50V	CH	GRM39CH101J50PT	K22174235		1-		
CD1001	CERAMIC DISC				CDBM450C7	H7900930		1-		
CF1001	CERAMIC FILTER				SFECV10.7MS2-A-TC	H3900514		1-	B	b4
CF1002	CERAMIC FILTER				ELFC450F	H3900552		1-	B	a5
D 1001	DIODE				1SS362 TE85R	G2070268		1-	B	d3
D 1002	DIODE				1SS362 TE85R	G2070268		1-	B	d3
D 1003	DIODE				1SV307(TPH3)	G2070638		1-	A	C7
D 1004	LED				CL-165HR/YG-D-T	G2070860		1-	A	C1
D 1005	DIODE				1SV271 TPH3	G2070476		1-	A	B1
D 1006	DIODE				DAN222M T2L	G2070936		1-	A	C7
D 1007	DIODE				DA221M T2L	G2070940		1-	A	D1
D 1008	DIODE				DA221M T2L	G2070940		1-	A	C1
D 1009	DIODE				DA221M T2L	G2070940		1-	A	C1
D 1010	DIODE				DA221M T2L	G2070940		1-	A	E5
D 1011	LED				19-215UYOC/S530-A2/TR8	G2070884		1-	A	D5
D 1012	LED				19-215UYOC/S530-A2/TR8	G2070884		1-	A	C4
D 1013	LED				19-215UYOC/S530-A2/TR8	G2070884		1-	A	A5
D 1014	LED				19-215UYOC/S530-A2/TR8	G2070884		1-	A	A7
D 1015	DIODE				UDZS TE-17 5.1B	G2070908		1-	A	C6
D 1016	DIODE				HVC355B(TAPE)	G2070588		1-	A	B6
D 1017	DIODE				HVC355B(TAPE)	G2070588		1-	A	B7
D 1018	DIODE				HVC358B(TAPE)	G2070590		1-	B	d4
D 1019	DIODE				HVC358B(TAPE)	G2070590		1-	B	d4
D 1020	DIODE				1SV325(TPH3)	G2070848		1-	B	c4
D 1021	DIODE				1SV325(TPH3)	G2070848		1-	B	c4
D 1022	DIODE				HVC369B TRF	G2070872		1-	B	c4
D 1023	DIODE				1SV325(TPH3)	G2070848		1-	B	c4
D 1024	DIODE				1SV325(TPH3)	G2070848		1-	B	c4
D 1025	DIODE				HVC369B TRF	G2070872		1-	B	c4
D 1026	DIODE				HVR100-8TRU	G2070540		1-	B	b8
D 1027	DIODE				DAN222M T2L	G2070936		1-	A	C8
D 1028	DIODE				DAN222M T2L	G2070936		1-	A	C7
D 1029	LED				CL-191WB-D(TAPE)	G2070952		1-	A	C1
D 1030	DIODE				1SS400G T2R	G2070934		1-	A	D6
D 1031	DIODE				1SS400G T2R	G2070934		1-	A	B7
D 1032	DIODE				HVC358B(TAPE)	G2070590		1-	B	c4
D 1033	DIODE				HVC358B(TAPE)	G2070590		1-	B	c4
D 1034	DIODE				1SV325(TPH3)	G2070848		1-	B	b4
D 1035	DIODE				1SV325(TPH3)	G2070848		1-	B	b4

MAIN Unit

Parts List

REF	DESCRIPTION	VALUE	V/W	TOL.	MFR'S DESIG	VXSTD P/N	VERS.	LOT	SIDE	LAY ADR
D 1036	DIODE				1SS400G T2R	G2070934		1-	A	B7
D 1037	DIODE				DAP222M T2L	G2070938		1-	B	b3
D 1038	DIODE				1SS400G T2R	G2070934		1-	B	b3
D 1039	DIODE				1SS400G T2R	G2070934		1-	B	b3
D 1040	DIODE				HN2D01FUTE85R	G2070348		1-	B	c5
D 1041	DIODE				DAN222M T2L	G2070936		1-	B	b5
D 1042	DIODE				DA221M T2L	G2070940		1-	B	b4
D 1043	DIODE				DAN222M T2L	G2070936		1-	B	a4
D 1044	DIODE				HVC359 TRF	G2070708		1-	B	c6
D 1045	DIODE				DAN222M T2L	G2070936		1-	B	a6
D 1046	DIODE				DAN222M T2L	G2070936		1-	B	a6
D 1047	DIODE				DAN222M T2L	G2070936		1-	B	d4
D 1048	DIODE				DAN222M T2L	G2070936		1-	B	d4
D 1049	DIODE				DA221M T2L	G2070940		1-	B	b6
D 1050	DIODE				DA221M T2L	G2070940		1-	B	b7
D 1051	DIODE				RB751S-40TE61	G2070850		1-	B	b7
D 1052	DIODE				1SS400G T2R	G2070934		1-	A	C5
D 1054	DIODE				DA221M T2L	G2070940		1-	A	D3
D 1055	DIODE				DA221M T2L	G2070940		1-	A	D2
D 1056	DIODE				1SS385(TE85L)	G2070880		1-	A	B5
D 1057	DIODE				RLS135 TE-11	G2070128		1-	B	d3
D 1058	DIODE				RLS135 TE-11	G2070128		1-	B	d2
D 1059	DIODE				1SV307(TPH3)	G2070638		1-	B	d3
D 1060	DIODE				1SV307(TPH3)	G2070638		1-	B	c3
D 1061	DIODE				1SS400G T2R	G2070934		1-	A	D2
D 1062	DIODE				RB521S-30 TE61	G2070642		1-	A	E3
D 1063	DIODE				RB521S-30 TE61	G2070642		1-	A	D2
D 1064	DIODE				RB751S-40TE61	G2070850		1-	B	b2
D 1065	DIODE				1SS400G T2R	G2070934		1-	A	C5
D 1066	DIODE				1SS400G T2R	G2070934		1-	A	B6
D 1067	DIODE				1SS400G T2R	G2070934		1-	A	A8
D 1068	DIODE				1SV271 TPH3	G2070476		1-	B	d2
D 1069	DIODE				1SV271 TPH3	G2070476		1-	B	d2
D 1070	DIODE				1SS400G T2R	G2070934		1-	B	b2
D 1071	DIODE				1SS400G T2R	G2070934		1-	A	C5
D 1072	DIODE				UMP11N TN	G2070646		1-	B	c5
D 1073	DIODE				UMP11N TN	G2070646		1-	B	c5
D 1074	DIODE				M1FM3-4063	G2070804		1-	B	a4
D 1075	DIODE				M1FM3-4063	G2070804		1-	B	b2
D 1076	DIODE				1SS400G T2R	G2070934		1-	B	d5
D 1077	DIODE				1SS400G T2R	G2070934		1-	B	d5
D 1078	DIODE				DA221M T2L	G2070940		1-	A	A2
D 1079	DIODE				1SS400G T2R	G2070934		1-	A	D3
D 1080	DIODE				1SS400G T2R	G2070934		1-	B	a6
DS1001	LCD				64210	G6090152		1-	A	C2
FB1001	CHIP COIL				BLM21P300SPT	L1690840		1-	A	D2
FB1002	CHIP COIL				BLM21P300SPT	L1690840		1-	B	a2
FB1003	CHIP COIL				BLM10A121SPT	L1690843		1-	A	C1
FB1004	CHIP COIL				BLM10A121SPT	L1690843		1-	A	C2
FB1005	CHIP COIL				BLM10A121SPT	L1690843		1-	A	B2
FB1006	CHIP COIL				BLM10A121SPT	L1690843		1-	A	B2
FB1007	CHIP COIL				BLM10A121SPT	L1690843		1-	A	B1
J 1001	CONNECTOR				AXK6F10335P	P0091225		1-	B	d6
J 1002	CONNECTOR				AXK6F10335P	P0091225		1-	B	b6
J 1003	CONNECTOR				AXK6F10335P	P0091225		1-	B	c5
J 1004	CONNECTOR				HEC4306-010020	P0091358		1-	B	a2
J 1005	SHIELD FINGER				2026 3100012	S5000196		1-	A	B7
J 1006	SHIELD FINGER				2026 3100012	S5000196		1-	A	D7
J 1007	CONNECTOR				HSJ1594-010055	P1090896		1-	B	c1
L 1001	M.RFC	0.01uH			ELJ-RF10NJF2	L1690831		1-	A	B1
L 1002	M.RFC	0.12uH			LK1608 R12K-T	L1690408		1-	A	A1
L 1003	M.RFC	0.0082uH			TFL0510-8N2	L1690810		1-	A	B1
L 1004	M.RFC	0.01uH			ELJ-RF10NJF2	L1690831		1-	A	B1
L 1005	M.RFC	0.015uH			TFL0510-15N	L1690813		1-	A	B6
L 1006	M.RFC	0.033uH		2%	C1608CA-33NG	L1691038		1-	B	d4
L 1007	M.RFC	0.0068uH		5%	C1608CA-6N8J	L1691093		1-	B	d4
L 1008	M.RFC	0.01uH		2%	C1608CA-10NG	L1691032		1-	B	d4
L 1009	M.RFC	0.15uH			LK1608 R15K-T	L1690409		1-	B	c3
L 1010	M.RFC	0.056uH			HK1608 56NJ-T	L1690525		1-	B	c3
L 1011	M.RFC	0.15uH			LK1608 R15K-T	L1690409		1-	B	c3
L 1012	M.RFC	120uH			FLC32T-121J	L1690228		1-	B	b7
L 1013	M.RFC	33uH			LK1608 330M-T	L1690690		1-	A	C7
L 1014	M.RFC	0.0056uH			TFL0510-5N6	L1690808		1-	A	B6

MAIN Unit

Parts List

REF	DESCRIPTION	VALUE	V/W	TOL.	MFR'S DESIG	VXSTD P/N	VERS.	LOT	SIDE	LAY ADR
L 1015	M.RFC	0.0056uH			TFL0510-5N6	L1690808		1-	A	B6
L 1016	M.RFC	0.01uH		2%	C1608CA-10NG	L1691032		1-	B	c4
L 1017	M.RFC	0.01uH		2%	C1608CA-10NG	L1691032		1-	B	c4
L 1018	M.RFC	0.082uH		2%	C1608CA-82NG	L1691044		1-	B	c4
L 1019	M.RFC	0.082uH		2%	C1608CA-82NG	L1691044		1-	B	c4
L 1020	M.RFC	0.1uH			LK1608 R10K-T	L1690407		1-	A	C7
L 1021	M.RFC	0.1uH			LK1608 R10K-T	L1690407		1-	A	C7
L 1022	M.RFC	33uH			LK1608 330M-T	L1690690		1-	A	C8
L 1024	M.RFC	0.01uH		2%	C1608CA-10NG	L1691032		1-	B	c4
L 1025	M.RFC	0.082uH		2%	C1608CA-82NG	L1691044		1-	B	b4
L 1026	M.RFC	33uH			LK1608 330M-T	L1690690		1-	A	B7
L 1027	M.RFC	0.39uH			LK1608 R39K-T	L1690413		1-	B	b3
L 1028	M.RFC	0.15uH			LK1608 R15K-T	L1690409		1-	B	b3
L 1029	M.RFC	0.33uH			LK1608 R33K-T	L1690412		1-	B	a3
L 1030	M.RFC	1uH			LK1608 1R0K-T	L1690687		1-	B	c7
L 1031	M.RFC	0.47uH			LK1608 R47K-T	L1690414		1-	B	c7
L 1032	M.RFC	0.22uH			LK1608 R22K-T	L1690410		1-	B	c7
L 1033	M.RFC	0.33uH		2%	C1608CA-R33G	L1691106		1-	B	a4
L 1034	M.RFC	4.7uH			LK1608 4R7K-T	L1690688		1-	B	d7
L 1035	M.RFC	0.22uH			LK1608 R22K-T	L1690410		1-	B	c7
L 1036	M.RFC	470uH			FLC32T-471J	L1690235		1-	B	d6
L 1037	M.RFC	10uH		2%	KQ1008TE100G	L1691216		1-	A	C5
L 1038	M.RFC	0.022uH			TFL0510-22N	L1690815		1-	B	c5
L 1039	M.RFC	0.033uH			TFL0510-33N	L1690817		1-	B	d4
L 1040	M.RFC	0.022uH			TFL0510-22N	L1690815		1-	B	d4
L 1041	M.RFC	150uH			FLC32T-151J	L1690229		1-	A	D4
L 1042	COIL				E2 0.4-1.3-2T-L	L0022580		1-	B	d3
L 1043	M.RFC	4.7uH			LK1608 4R7K-T	L1690688		1-	B	d3
L 1044	COIL				E2 0.28-1.0-4.5T-R	L0022395		1-	B	d2
L 1045	COIL				E2 0.28-1.0-4T-R	L0022365		1-	B	d3
L 1046	M.RFC	4.7uH			LK1608 4R7K-T	L1690688		1-	B	d3
L 1047	COIL				E2 0.35-1.6-7T-L	L0022390		1-	B	c3
L 1048	M.RFC	150uH			FLC32P-T-151K	L1690661		1-	B	b2
L 1049	COIL				E2 0.35-1.4-3.5T-L-B	L0022729		1-	B	d2
L 1050	COIL				E2 0.35-1.4-3.5T-L-B	L0022729		1-	B	d2
L 1051	COIL				E2 0.25-1.9-6.5T-L	L0022401		1-	B	c2
L 1052	COIL				E2 0.25-1.9-6.5T-L	L0022401		1-	B	c2
L 1053	COIL				E2 0.35-1.6-4T-L	L0022456		1-	B	d1
L 1054	COIL				E2 0.25-1.9-6.5T-L	L0022401		1-	B	d2
L 1055	COIL				E2 0.35-1.6-4T-L	L0022456		1-	B	d1
L 1056	COIL				E2 0.25-1.9-6.5T-L	L0022401		1-	B	d1
L 1057	M.RFC	0.18uH			LK1608 R18K-T	L1690392		1-	A	A1
MC1001	MIC. ELEMENT				SKB-2244S-C1033G04	M3290039		1-	A	B5
Q 1001	TRANSISTOR				UMW1 TR	G3070078		1-	A	C1
Q 1002	TRANSISTOR				2SC5277-D2-TL	G3352778B		1-	A	B6
Q 1003	TRANSISTOR				DTC144EM T2L	G3070309		1-	A	B6
Q 1004	TRANSISTOR				2SC5555ZD-TR	G3355557		1-	B	d4
Q 1005	TRANSISTOR				2SC5555ZD-TR	G3355557		1-	B	c4
Q 1006	TRANSISTOR				DTC143TE TL	G3070222		1-	A	E4
Q 1007	TRANSISTOR				DTA144EM T2L	G3070310		1-	A	D6
Q 1008	TRANSISTOR				2SC5555ZD-TR	G3355557		1-	B	c4
Q 1009	TRANSISTOR				2SC5555ZD-TR	G3355557		1-	A	B7
Q 1010	IC				M62364FP 600D	G1093033		1-	B	a7
Q 1011	TRANSISTOR				2SC4617 TL R	G3346178R		1-	A	D1
Q 1012	TRANSISTOR				2SC5277-D2-TL	G3352778B		1-	A	B7
Q 1013	TRANSISTOR				2SC5555ZD-TR	G3355557		1-	B	b4
Q 1014	TRANSISTOR				2SC5555ZD-TR	G3355557		1-	B	b3
Q 1015	TRANSISTOR				2SC5555ZD-TR	G3355557		1-	A	C7
Q 1016	IC				NJU7007F2-TE1	G1093617		1-	A	D8
Q 1017	TRANSISTOR				2SC4915-O(TE85L)	G3349158O		1-	B	a4
Q 1018	TRANSISTOR				EMG2 T2R	G3070304		1-	B	b3
Q 1019	TRANSISTOR				2SC4617 TL R	G3346178R		1-	A	A5
Q 1020	TRANSISTOR				2SC4915-O(TE85L)	G3349158O		1-	B	b3
Q 1021	TRANSISTOR				2SC4915-O(TE85L)	G3349158O		1-	B	b4
Q 1022	TRANSISTOR				2SC4915-O(TE85L)	G3349158O		1-	B	c7
Q 1023	TRANSISTOR				2SC4915-O(TE85L)	G3349158O		1-	B	c7
Q 1024	TRANSISTOR				2SC5374-TL	G3353748		1-	B	c5
Q 1025	TRANSISTOR				2SC5374-TL	G3353748		1-	B	b5
Q 1026	TRANSISTOR				2SC5374-TL	G3353748		1-	B	c5
Q 1027	TRANSISTOR				2SA1774 TL R	G3117748R		1-	B	d8
Q 1028	TRANSISTOR				2SC4915-O(TE85L)	G3349158O		1-	B	d7
Q 1029	TRANSISTOR				EMB3 T2R	G3070303		1-	B	d5
Q 1030	TRANSISTOR				EMG2 T2R	G3070304		1-	B	d5

MAIN Unit

Parts List

REF	DESCRIPTION	VALUE	V/W	TOL.	MFR'S DESIG	VXSTD P/N	VERS.	LOT	SIDE	LAY ADR
Q 1031	TRANSISTOR				DTC144EM T2L	G3070309		1-	B	d7
Q 1032	TRANSISTOR				2SA1774 TL R	G3117748R		1-	B	d7
Q 1033	IC				TA31136FN(EL)	G1091605		1-	B	b5
Q 1034	IC				MB15A01PFV1-G-BND-EF	G1092545		1-	B	c6
Q 1035	TRANSISTOR				2SC4915-O(TE85L)	G3349158O		1-	B	d7
Q 1036	TRANSISTOR				DTA144EM T2L	G3070310		1-	B	d5
Q 1037	TRANSISTOR				EMB3 T2R	G3070303		1-	A	D5
Q 1038	TRANSISTOR				DTC144EM T2L	G3070309		1-	A	C5
Q 1039	TRANSISTOR				DTC144EM T2L	G3070309		1-	B	b5
Q 1040	TRANSISTOR				2SC4617 TL R	G3346178R		1-	B	b6
Q 1041	TRANSISTOR				2SC4617 TL R	G3346178R		1-	B	b6
Q 1042	TRANSISTOR				2SC4617 TL R	G3346178R		1-	B	b7
Q 1043	TRANSISTOR				DTC144EM T2L	G3070309		1-	A	B6
Q 1044	FET				2SJ364-R(TX)	G3703648R		1-	A	C6
Q 1045	TRANSISTOR				2SC4617 TL R	G3346178R		1-	A	C5
Q 1046	TRANSISTOR				2SA1774 TL R	G3117748R		1-	A	C5
Q 1047	TRANSISTOR				EMB3 T2R	G3070303		1-	A	C6
Q 1048	TRANSISTOR				EMB3 T2R	G3070303		1-	A	C5
Q 1049	TRANSISTOR				EMG2 T2R	G3070304		1-	A	C5
Q 1050	TRANSISTOR				2SA1774 TL R	G3117748R		1-	A	B6
Q 1051	TRANSISTOR				EMB3 T2R	G3070303		1-	A	B7
Q 1052	TRANSISTOR				DTC144EM T2L	G3070309		1-	A	B7
Q 1053	FET				2SJ364-R(TX)	G3703648R		1-	A	C6
Q 1054	TRANSISTOR				UMD6N TR	G3070215		1-	A	B6
Q 1055	TRANSISTOR				EMG2 T2R	G3070304		1-	A	B6
Q 1056	TRANSISTOR				EMB10 T2R	G3070302		1-	A	B6
Q 1057	TRANSISTOR				2SA1774 TL R	G3117748R		1-	A	B6
Q 1058	TRANSISTOR				EMB3 T2R	G3070303		1-	A	B6
Q 1059	IC				BU4094BCFV-E2	G1093527		1-	A	A3
Q 1060	IC				BU4094BCFV-E2	G1093527		1-	A	A3
Q 1061	TRANSISTOR				CPH6102-TL	G3070223		1-	B	a3
Q 1062	TRANSISTOR				2SC4617 TL R	G3346178R		1-	A	D3
Q 1063	IC				TAR5S30(TE85L)	G1093570		1-	B	b2
Q 1064	TRANSISTOR				UMW1 TR	G3070078		1-	B	a3
Q 1065	TRANSISTOR				2SC5374-TL	G3353748		1-	A	D3
Q 1066	IC				S-80830CNMC-B8P-T2	G1093618		1-	A	D3
Q 1067	IC				S-80830CNMC-B8P-T2	G1093618		1-	A	D2
Q 1068	IC				NJU7231F30(TE1)	G1093512		1-	A	D2
Q 1069	IC				RH5RH651A-T1	G1092598		1-	B	b3
Q 1070	TRANSISTOR				2SA1774 TL R	G3117748R		1-	A	C5
Q 1071	TRANSISTOR				2SC4617 TL R	G3346178R		1-	A	C6
Q 1072	TRANSISTOR				DTC144EM T2L	G3070309		1-	A	A2
Q 1073	FET				MCH6305-TL	G3070301		1-	B	b3
Q 1074	TRANSISTOR				DTC144EM T2L	G3070309		1-	A	B3
Q 1075	TRANSISTOR				2SC4617 TL R	G3346178R		1-	A	C6
Q 1076	IC				HD64F2266TF13	×		1-	A	C3
Q 1077	IC				MM1438BWLE	G1093814		1-	B	a4
Q 1078	TRANSISTOR				CPH6102-TL	G3070223		1-	B	a4
Q 1079	IC				NJM2135V-TE1	G1092438		1-	B	b7
Q 1080	IC				AT24C256N-10SI-1.8	G1093837		1-	A	A2
Q 1081	TRANSISTOR				KRX202U-RTK	G3070277		1-	A	B2
Q 1082	IC				NJM12904R(TE1)	G1093337		1-	A	D7
Q 1083	IC				NJM3403AV(TE1)	G1092215		1-	A	D6
Q 1084	TRANSISTOR				DTC144EM T2L	G3070309		1-	A	D3
R 1001	CHIP RES.	4.7k	1/16W	5%	RMC1/16S 472JTH	J24189033		1-	B	d4
R 1002	CHIP RES.	3.3k	1/16W	5%	RMC1/16S 332JTH	J24189031		1-	B	c3
R 1003	CHIP RES.	1k	1/16W	5%	RMC1/16S 102JTH	J24189025		1-	A	D1
R 1004	CHIP RES.	1k	1/16W	5%	RMC1/16S 102JTH	J24189025		1-	A	C1
R 1005	CHIP RES.	1k	1/16W	5%	RMC1/16S 102JTH	J24189025		1-	A	C1
R 1006	CHIP RES.	220	1/16W	5%	RMC1/16S 221JTH	J24189017		1-	A	D1
R 1007	CHIP RES.	100	1/16W	5%	RMC1/16S 101JTH	J24189013		1-	A	D1
R 1008	CHIP RES.	1k	1/16W	5%	RMC1/16S 102JTH	J24189025		1-	A	B6
R 1009	CHIP RES.	47k	1/16W	5%	RMC1/16S 473JTH	J24189045		1-	A	B6
R 1010	CHIP RES.	100k	1/16W	5%	RMC1/16S 104JTH	J24189049		1-	B	d4
R 1011	CHIP RES.	3.3k	1/16W	5%	RMC1/16S 332JTH	J24189031		1-	A	B6
R 1012	CHIP RES.	220	1/16W	5%	RMC1/16S 221JTH	J24189017		1-	B	d4
R 1013	CHIP RES.	220	1/16W	5%	RMC1/16S 221JTH	J24189017		1-	A	B6
R 1014	CHIP RES.	47k	1/16W	5%	RMC1/16S 473JTH	J24189045		1-	B	d4
R 1015	CHIP RES.	220	1/16W	5%	RMC1/16S 221JTH	J24189017		1-	B	c3
R 1016	CHIP RES.	1k	1/16W	5%	RMC1/16S 102JTH	J24189025		1-	B	c3
R 1017	CHIP RES.	4.7k	1/16W	5%	RMC1/16S 472JTH	J24189033		1-	A	C7
R 1018	CHIP RES.	470	1/16W	5%	RMC1/16S 471JTH	J24189021		1-	A	C7
R 1019	CHIP RES.	100k	1/16W	5%	RMC1/16S 104JTH	J24189049		1-	A	D8

×: Please contact Vertex Standard

MAIN Unit

Parts List

REF	DESCRIPTION	VALUE	V/W	TOL.	MFR'S DESIG	VXSTD P/N	VERS.	LOT	SIDE	LAY ADR
R 1020	CHIP RES.	100	1/16W	5%	RMC1/16S 101JTH	J24189013		1-	B	a7
R 1021	CHIP RES.	1k	1/16W	5%	RMC1/16S 102JTH	J24189025		1-	A	C7
R 1022	CHIP RES.	100	1/16W	5%	RMC1/16S 101JTH	J24189013		1-	B	a7
R 1023	CHIP RES.	100	1/16W	5%	RMC1/16S 101JTH	J24189013		1-	B	a8
R 1024	CHIP RES.	100	1/16W	5%	RMC1/16S 101JTH	J24189013		1-	B	a7
R 1025	CHIP RES.	120	1/16W	5%	RMC1/16S 121JTH	J24189014		1-	A	A2
R 1026	CHIP RES.	220	1/16W	5%	RMC1/16S 221JTH	J24189017		1-	A	D5
R 1027	CHIP RES.	220	1/16W	5%	RMC1/16S 221JTH	J24189017		1-	A	D4
R 1028	CHIP RES.	220	1/16W	5%	RMC1/16S 221JTH	J24189017		1-	A	B7
R 1029	CHIP RES.	220	1/16W	5%	RMC1/16S 221JTH	J24189017		1-	A	B7
R 1030	CHIP RES.	1k	1/16W	5%	RMC1/16S 102JTH	J24189025		1-	A	C6
R 1031	CHIP RES.	5.6k	1/16W	5%	RMC1/16S 562JTH	J24189034		1-	A	C6
R 1032	CHIP RES.	2.2k	1/16W	5%	RMC1/16S 222JTH	J24189029		1-	A	C6
R 1033	CHIP RES.	100k	1/16W	5%	RMC1/16S 104JTH	J24189049		1-	A	B6
R 1034	CHIP RES.	100k	1/16W	5%	RMC1/16S 104JTH	J24189049		1-	B	d4
R 1035	CHIP RES.	100k	1/16W	5%	RMC1/16S 104JTH	J24189049		1-	B	c4
R 1036	CHIP RES.	100k	1/16W	5%	RMC1/16S 104JTH	J24189049		1-	B	c4
R 1037	CHIP RES.	100k	1/16W	5%	RMC1/16S 104JTH	J24189049		1-	A	B7
R 1038	CHIP RES.	100	1/16W	5%	RMC1/16S 101JTH	J24189013		1-	B	c4
R 1039	CHIP RES.	100k	1/16W	5%	RMC1/16S 104JTH	J24189049		1-	B	c4
R 1040	CHIP RES.	100k	1/16W	5%	RMC1/16S 104JTH	J24189049		1-	B	c4
R 1041	CHIP RES.	100k	1/16W	5%	RMC1/16S 104JTH	J24189049		1-	B	b4
R 1042	CHIP RES.	100k	1/16W	5%	RMC1/16S 104JTH	J24189049		1-	B	b4
R 1044	CHIP RES.	1k	1/16W	5%	RMC1/16S 102JTH	J24189025		1-	A	C7
R 1045	CHIP RES.	470	1/16W	5%	RMC1/16S 471JTH	J24189021		1-	A	C8
R 1046	CHIP RES.	47k	1/16W	5%	RMC1/16S 473JTH	J24189045		1-	A	B8
R 1047	CHIP RES.	100	1/16W	5%	RMC1/16S 101JTH	J24189013		1-	B	a7
R 1048	CHIP RES.	100	1/16W	5%	RMC1/16S 101JTH	J24189013		1-	B	a7
R 1049	CHIP RES.	100	1/16W	5%	RMC1/16S 101JTH	J24189013		1-	B	a8
R 1050	CHIP RES.	390k	1/16W	0.5%	MCR01MZPD3903	J24189331		1-	A	D7
R 1051	CHIP RES.	470k	1/16W	0.5%	MCR01MZPD4703	J24189332		1-	A	D7
R 1052	CHIP RES.	47	1/16W	5%	RMC1/16S 470JTH	J24189009		1-	A	C1
R 1053	CHIP RES.	22k	1/16W	5%	RMC1/16S 223JTH	J24189041		1-	A	D6
R 1054	CHIP RES.	180k	1/16W	5%	RMC1/16S 184JTH	J24189052		1-	A	D6
R 1055	CHIP RES.	47k	1/16W	5%	RMC1/16S 473JTH	J24189045		1-	A	D6
R 1056	CHIP RES.	330k	1/16W	5%	RMC1/16S 334JTH	J24189055		1-	A	D6
R 1057	CHIP RES.	100k	1/16W	5%	RMC1/16S 104JTH	J24189049		1-	A	C5
R 1058	CHIP RES.	10k	1/16W	5%	RMC1/16S 103JTH	J24189037		1-	A	D6
R 1059	CHIP RES.	10k	1/16W	5%	RMC1/16S 103JTH	J24189037		1-	A	D6
R 1060	CHIP RES.	47k	1/16W	5%	RMC1/16S 473JTH	J24189045		1-	A	D7
R 1061	CHIP RES.	33k	1/16W	5%	RMC1/16S 333JTH	J24189043		1-	A	D6
R 1062	CHIP RES.	47k	1/16W	5%	RMC1/16S 473JTH	J24189045		1-	A	D6
R 1063	CHIP RES.	470	1/16W	5%	RMC1/16S 471JTH	J24189021		1-	A	C6
R 1064	CHIP RES.	330k	1/16W	5%	RMC1/16S 334JTH	J24189055		1-	A	B7
R 1065	CHIP RES.	470	1/16W	5%	RMC1/16S 471JTH	J24189021		1-	A	B7
R 1066	CHIP RES.	100k	1/16W	5%	RMC1/16S 104JTH	J24189049		1-	B	c4
R 1067	CHIP RES.	1k	1/16W	5%	RMC1/16S 102JTH	J24189025		1-	A	B7
R 1068	CHIP RES.	100k	1/16W	5%	RMC1/16S 104JTH	J24189049		1-	B	c4
R 1069	CHIP RES.	220k	1/16W	5%	RMC1/16S 224JTH	J24189053		1-	B	b4
R 1070	CHIP RES.	1k	1/16W	5%	RMC1/16S 102JTH	J24189025		1-	B	b4
R 1071	CHIP RES.	220	1/16W	5%	RMC1/16S 221JTH	J24189017		1-	B	b4
R 1072	CHIP RES.	100k	1/16W	5%	RMC1/16S 104JTH	J24189049		1-	B	b4
R 1073	CHIP RES.	220k	1/16W	5%	RMC1/16S 224JTH	J24189053		1-	B	b3
R 1074	CHIP RES.	1k	1/16W	5%	RMC1/16S 102JTH	J24189025		1-	B	b4
R 1075	CHIP RES.	220	1/16W	5%	RMC1/16S 221JTH	J24189017		1-	B	b3
R 1076	CHIP RES.	47	1/16W	5%	RMC1/16S 470JTH	J24189009		1-	A	C7
R 1077	CHIP RES.	470	1/16W	5%	RMC1/16S 471JTH	J24189021		1-	A	C7
R 1078	CHIP RES.	470k	1/16W	5%	RMC1/16S 474JTH	J24189057		1-	A	C7
R 1080	CHIP RES.	330	1/16W	5%	RMC1/16S 331JTH	J24189019		1-	A	C7
R 1081	CHIP RES.	330k	1/16W	0.5%	MCR01MZPD3303	J24189330		1-	A	D7
R 1082	CHIP RES.	270k	1/16W	0.5%	MCR01MZPD2703	J24189329		1-	A	D7
R 1083	CHIP RES.	10k	1/16W	5%	RMC1/16S 103JTH	J24189037		1-	A	D7
R 1084	CHIP RES.	560k	1/16W	0.5%	MCR01MZPD5603	J24189335		1-	A	D7
R 1085	CHIP RES.	1M	1/16W	1%	MCR01MZSF1004	J24189333		1-	A	D7
R 1086	CHIP RES.	270k	1/16W	0.5%	MCR01MZPD2703	J24189329		1-	A	D7
R 1087	CHIP RES.	820k	1/16W	0.5%	MCR01MZPD8203	J24189336		1-	A	D7
R 1088	CHIP RES.	100k	1/16W	0.5%	RR0510R-104-D	J24189167		1-	A	D7
R 1089	CHIP RES.	270k	1/16W	5%	RMC1/16S 274JTH	J24189054		1-	A	D6
R 1090	CHIP RES.	270k	1/16W	5%	RMC1/16S 274JTH	J24189054		1-	A	D6
R 1091	CHIP RES.	5.6k	1/16W	5%	RMC1/16S 562JTH	J24189034		1-	A	D6
R 1092	CHIP RES.	5.6k	1/16W	5%	RMC1/16S 562JTH	J24189034		1-	A	D6
R 1093	CHIP RES.	4.7k	1/16W	5%	RMC1/16S 472JTH	J24189033		1-	A	D7
R 1094	CHIP RES.	2.2k	1/16W	5%	RMC1/16S 222JTH	J24189029		1-	A	D7

MAIN Unit

Parts List

REF	DESCRIPTION	VALUE	V/W	TOL.	MFR'S DESIG	VXSTD P/N	VERS.	LOT	SIDE	LAY ADR
R 1095	CHIP RES.	470	1/16W	5%	RMC1/16S 471JTH	J24189021		1-	B	b3
R 1096	CHIP RES.	10k	1/16W	5%	RMC1/16S 103JTH	J24189037		1-	A	A6
R 1097	CHIP RES.	10k	1/16W	5%	RMC1/16S 103JTH	J24189037		1-	B	c5
R 1098	CHIP RES.	18k	1/16W	5%	RMC1/16S 183JTH	J24189040		1-	B	b5
R 1099	CHIP RES.	1M	1/16W	5%	RMC1/16S 105JTH	J24189061		1-	A	D6
R 1100	CHIP RES.	1M	1/16W	5%	RMC1/16S 105JTH	J24189061		1-	A	D6
R 1101	CHIP RES.	4.7k	1/16W	5%	RMC1/16S 472JTH	J24189033		1-	A	D7
R 1102	CHIP RES.	470k	1/16W	5%	RMC1/16S 474JTH	J24189057		1-	A	C6
R 1103	CHIP RES.	10k	1/16W	5%	RMC1/16S 103JTH	J24189037		1-	A	D7
R 1104	CHIP RES.	4.7k	1/16W	5%	RMC1/16S 472JTH	J24189033		1-	A	E7
R 1105	CHIP RES.	10k	1/16W	5%	RMC1/16S 103JTH	J24189037		1-	A	D7
R 1106	CHIP RES.	330	1/16W	5%	RMC1/16S 331JTH	J24189019		1-	B	b3
R 1107	CHIP RES.	470	1/16W	5%	RMC1/16S 471JTH	J24189021		1-	B	a4
R 1108	CHIP RES.	470	1/16W	5%	RMC1/16S 471JTH	J24189021		1-	B	b3
R 1109	CHIP RES.	100k	1/16W	5%	RMC1/16S 104JTH	J24189049		1-	B	a4
R 1110	CHIP RES.	100k	1/16W	5%	RMC1/16S 104JTH	J24189049		1-	A	A5
R 1111	CHIP RES.	1k	1/16W	5%	RMC1/16S 102JTH	J24189025		1-	B	d7
R 1112	CHIP RES.	100k	1/16W	5%	RMC1/16S 104JTH	J24189049		1-	B	d7
R 1113	CHIP RES.	470k	1/16W	5%	RMC1/16S 474JTH	J24189057		1-	B	b3
R 1114	CHIP RES.	100	1/16W	5%	RMC1/16S 101JTH	J24189013		1-	B	b4
R 1115	CHIP RES.	470k	1/16W	5%	RMC1/16S 474JTH	J24189057		1-	B	b4
R 1116	CHIP RES.	150k	1/16W	5%	RMC1/16S 154JTH	J24189051		1-	B	c7
R 1117	CHIP RES.	100	1/16W	5%	RMC1/16S 101JTH	J24189013		1-	B	c7
R 1119	CHIP RES.	100	1/16W	5%	RMC1/16S 101JTH	J24189013		1-	B	c7
R 1120	CHIP RES.	33k	1/16W	5%	RMC1/16S 333JTH	J24189043		1-	B	b6
R 1121	CHIP RES.	100	1/16W	5%	RMC1/16S 101JTH	J24189013		1-	B	a4
R 1122	CHIP RES.	1k	1/16W	5%	RMC1/16S 102JTH	J24189025		1-	B	a4
R 1124	CHIP RES.	1k	1/16W	5%	RMC1/16S 102JTH	J24189025		1-	B	b4
R 1125	CHIP RES.	1k	1/16W	5%	RMC1/16S 102JTH	J24189025		1-	B	a5
R 1126	CHIP RES.	330	1/16W	5%	RMC1/16S 331JTH	J24189019		1-	B	b4
R 1127	CHIP RES.	10k	1/16W	5%	RMC1/16S 103JTH	J24189037		1-	B	d7
R 1128	CHIP RES.	47k	1/16W	5%	RMC1/16S 473JTH	J24189045		1-	B	c6
R 1129	CHIP RES.	330k	1/16W	5%	RMC1/16S 334JTH	J24189055		1-	B	c6
R 1130	CHIP RES.	100k	1/16W	5%	RMC1/16S 104JTH	J24189049		1-	B	c6
R 1131	CHIP RES.	100k	1/16W	5%	RMC1/16S 104JTH	J24189049		1-	B	c6
R 1132	CHIP RES.	1M	1/16W	5%	RMC1/16S 105JTH	J24189061		1-	B	d7
R 1133	CHIP RES.	10k	1/16W	5%	RMC1/16S 103JTH	J24189037		1-	B	d8
R 1134	CHIP RES.	10k	1/16W	5%	RMC1/16S 103JTH	J24189037		1-	B	d7
R 1135	CHIP RES.	220	1/16W	5%	RMC1/16S 221JTH	J24189017		1-	B	a6
R 1136	CHIP RES.	100k	1/16W	5%	RMC1/16S 104JTH	J24189049		1-	A	B3
R 1137	CHIP RES.	1.5k	1/16W	5%	RMC1/16S 152JTH	J24189027		1-	B	b5
R 1138	CHIP RES.	10k	1/16W	5%	RMC1/16S 103JTH	J24189037		1-	B	a6
R 1139	CHIP RES.	22k	1/16W	5%	RMC1/16S 223JTH	J24189041		1-	B	a6
R 1140	CHIP RES.	100	1/16W	5%	RMC1/16S 101JTH	J24189013		1-	B	a6
R 1141	CHIP RES.	100	1/16W	5%	RMC1/16S 101JTH	J24189013		1-	B	a6
R 1142	CHIP RES.	330k	1/16W	5%	RMC1/16S 334JTH	J24189055		1-	B	b6
R 1143	CHIP RES.	10k	1/16W	5%	RMC1/16S 103JTH	J24189037		1-	B	a6
R 1144	CHIP RES.	10k	1/16W	5%	RMC1/16S 103JTH	J24189037		1-	B	a6
R 1145	CHIP RES.	1k	1/16W	5%	RMC1/16S 102JTH	J24189025		1-	B	c5
R 1146	CHIP RES.	1k	1/16W	5%	RMC1/16S 102JTH	J24189025		1-	B	c6
R 1147	CHIP RES.	1k	1/16W	5%	RMC1/16S 102JTH	J24189025		1-	B	c5
R 1148	CHIP RES.	3.3k	1/16W	5%	RMC1/16S 332JTH	J24189031		1-	B	c6
R 1149	CHIP RES.	1.5k	1/16W	5%	RMC1/16S 152JTH	J24189027		1-	B	d6
R 1150	CHIP RES.	1k	1/16W	5%	RMC1/16S 102JTH	J24189025		1-	B	d7
R 1151	CHIP RES.	330k	1/16W	5%	RMC1/16S 334JTH	J24189055		1-	B	d7
R 1152	CHIP RES.	1.8k	1/16W	5%	RMC1/16S 182JTH	J24189028		1-	B	d6
R 1153	CHIP RES.	1.8k	1/16W	5%	RMC1/16S 182JTH	J24189028		1-	B	e6
R 1154	CHIP RES.	1k	1/16W	5%	RMC1/16S 102JTH	J24189025		1-	B	d6
R 1155	CHIP RES.	220	1/16W	5%	RMC1/16S 221JTH	J24189017		1-	A	C5
R 1156	CHIP RES.	10k	1/16W	5%	RMC1/16S 103JTH	J24189037		1-	B	b5
R 1157	CHIP RES.	4.7k	1/16W	5%	RMC1/16S 472JTH	J24189033		1-	B	b5
R 1158	CHIP RES.	10k	1/16W	5%	RMC1/16S 103JTH	J24189037		1-	B	b5
R 1159	CHIP RES.	680	1/16W	5%	RMC1/16S 681JTH	J24189023		1-	B	b6
R 1160	CHIP RES.	3.3k	1/16W	5%	RMC1/16S 332JTH	J24189031		1-	B	b6
R 1161	CHIP RES.	0	1/16W	5%	RMC1/16S JPTH	J24189070		1-	B	a6
R 1162	CHIP RES.	3.3k	1/16W	5%	RMC1/16S 332JTH	J24189031		1-	B	b6
R 1163	CHIP RES.	330k	1/16W	5%	RMC1/16S 334JTH	J24189055		1-	B	b6
R 1164	CHIP RES.	560k	1/16W	5%	RMC1/16S 564JTH	J24189058		1-	B	a6
R 1165	CHIP RES.	3.3k	1/16W	5%	RMC1/16S 332JTH	J24189031		1-	B	b6
R 1166	CHIP RES.	1k	1/16W	5%	RMC1/16S 102JTH	J24189025		1-	B	b7
R 1167	CHIP RES.	220k	1/16W	5%	RMC1/16S 224JTH	J24189053		1-	B	b7
R 1168	CHIP RES.	10k	1/16W	5%	RMC1/16S 103JTH	J24189037		1-	B	a6
R 1169	CHIP RES.	470	1/16W	5%	RMC1/16S 471JTH	J24189021		1-	B	a6

MAIN Unit

Parts List

REF	DESCRIPTION	VALUE	V/W	TOL.	MFR'S DESIG	VXSTD P/N	VERS.	LOT	SIDE	LAY ADR
R 1170	CHIP RES.	4.7k	1/16W	5%	RMC1/16S 472JTH	J24189033		1-	B	b6
R 1171	CHIP RES.	3.3k	1/16W	5%	RMC1/16S 332JTH	J24189031		1-	B	d7
R 1172	CHIP RES.	2.2k	1/16W	5%	RMC1/16S 222JTH	J24189029		1-	B	d5
R 1173	CHIP RES.	1k	1/16W	5%	RMC1/16S 102JTH	J24189025		1-	B	d7
R 1174	CHIP RES.	330	1/16W	5%	RMC1/16S 331JTH	J24189019		1-	B	d4
R 1175	CHIP RES.	100	1/16W	5%	RMC1/16S 101JTH	J24189013		1-	B	d4
R 1176	CHIP RES.	330k	1/16W	5%	RMC1/16S 334JTH	J24189055		1-	A	D6
R 1177	CHIP RES.	10k	1/16W	5%	RMC1/16S 103JTH	J24189037		1-	A	C6
R 1178	CHIP RES.	330k	1/16W	5%	RMC1/16S 334JTH	J24189055		1-	A	D6
R 1179	CHIP RES.	15k	1/16W	5%	RMC1/16S 153JTH	J24189039		1-	A	D6
R 1180	CHIP RES.	1M	1/16W	5%	RMC1/16S 105JTH	J24189061		1-	B	b6
R 1181	CHIP RES.	100k	1/16W	5%	RMC1/16S 104JTH	J24189049		1-	B	c6
R 1182	CHIP RES.	100	1/16W	5%	RMC1/16S 101JTH	J24189013		1-	B	b7
R 1183	CHIP RES.	4.7k	1/16W	5%	RMC1/16S 472JTH	J24189033		1-	B	b6
R 1184	CHIP RES.	100k	1/16W	5%	RMC1/16S 104JTH	J24189049		1-	B	b6
R 1185	CHIP RES.	56k	1/16W	5%	RMC1/16S 563JTH	J24189046		1-	B	b7
R 1186	CHIP RES.	1k	1/16W	5%	RMC1/16S 102JTH	J24189025		1-	B	b7
R 1187	CHIP RES.	1k	1/16W	5%	RMC1/16S 102JTH	J24189025		1-	A	D5
R 1188	CHIP RES.	4.7k	1/16W	5%	RMC1/16S 472JTH	J24189033		1-	B	b7
R 1189	CHIP RES.	4.7k	1/16W	5%	RMC1/16S 472JTH	J24189033		1-	A	C5
R 1190	CHIP RES.	1k	1/16W	5%	RMC1/16S 102JTH	J24189025		1-	A	C5
R 1191	CHIP RES.	10k	1/16W	5%	RMC1/16S 103JTH	J24189037		1-	A	C6
R 1192	CHIP RES.	330k	1/16W	5%	RMC1/16S 334JTH	J24189055		1-	A	C6
R 1193	CHIP RES.	10k	1/16W	5%	RMC1/16S 103JTH	J24189037		1-	A	C6
R 1194	CHIP RES.	1k	1/16W	5%	RMC1/16S 102JTH	J24189025		1-	A	B6
R 1195	CHIP RES.	10k	1/16W	5%	RMC1/16S 103JTH	J24189037		1-	A	A3
R 1196	CHIP RES.	0	1/16W	5%	RMC1/16S JPTH	J24189070		1-	A	A3
R 1197	CHIP RES.	10k	1/16W	5%	RMC1/16S 103JTH	J24189037		1-	A	A3
R 1198	CHIP RES.	4.7k	1/16W	5%	RMC1/16S 472JTH	J24189033		1-	A	A5
R 1199	CHIP RES.	100k	1/16W	5%	RMC1/16S 104JTH	J24189049		1-	A	C3
R 1200	CHIP RES.	100k	1/16W	5%	RMC1/16S 104JTH	J24189049		1-	A	A4
R 1201	CHIP RES.	15k	1/16W	5%	RMC1/16S 153JTH	J24189039		1-	A	D3
R 1202	CHIP RES.	22k	1/16W	5%	RMC1/16S 223JTH	J24189041		1-	A	D3
R 1203	CHIP RES.	2.7k	1/16W	5%	RMC1/16S 272JTH	J24189030		1-	B	a3
R 1204	CHIP RES.	330k	1/16W	0.5%	MCR01MZPD3303	J24189330		1-	A	B2
R 1205	CHIP RES.	100k	1/16W	5%	RMC1/16S 104JTH	J24189049		1-	A	A2
R 1206	CHIP RES.	68k	1/16W	0.5%	RR0510R-683-D	J24189163		1-	A	A2
R 1208	CHIP RES.	47k	1/16W	5%	RMC1/16S 473JTH	J24189045		1-	A	B3
R 1209	CHIP RES.	2.2k	1/16W	5%	RMC1/16S 222JTH	J24189029		1-	A	D3
R 1210	CHIP RES.	1M	1/16W	5%	RMC1/16S 105JTH	J24189061		1-	A	D3
R 1211	CHIP RES.	220	1/16W	5%	RMC1/16S 221JTH	J24189017		1-	B	d4
R 1212	CHIP RES.	220	1/16W	5%	RMC1/16S 221JTH	J24189017		1-	B	d3
R 1213	CHIP RES.	22k	1/16W	5%	RMC1/16S 223JTH	J24189041		1-	A	D2
R 1214	CHIP RES.	68k	1/16W	5%	RMC1/16S 683JTH	J24189047		1-	A	D3
R 1215	CHIP RES.	33k	1/16W	5%	RMC1/16S 333JTH	J24189043		1-	A	D3
R 1216	CHIP RES.	22	1/16W	5%	RMC1/16S 220JTH	J24189005		1-	B	b2
R 1217	CHIP RES.	4.7	1/16W	5%	RMC1/16S 4R7JTH	J24189066		1-	B	c3
R 1218	CHIP RES.	470k	1/16W	5%	RMC1/16S 474JTH	J24189057		1-	A	C6
R 1219	CHIP RES.	2.7k	1/16W	5%	RMC1/16S 272JTH	J24189030		1-	A	C7
R 1220	CHIP RES.	220	1/16W	5%	RMC1/16S 221JTH	J24189017		1-	A	C6
R 1221	CHIP RES.	10k	1/16W	5%	RMC1/16S 103JTH	J24189037		1-	A	C7
R 1222	CHIP RES.	4.7k	1/16W	5%	RMC1/16S 472JTH	J24189033		1-	A	B5
R 1223	CHIP RES.	33k	1/16W	5%	RMC1/16S 333JTH	J24189043		1-	A	C6
R 1224	CHIP RES.	150k	1/16W	5%	RMC1/16S 154JTH	J24189051		1-	A	C6
R 1225	CHIP RES.	10k	1/16W	5%	RMC1/16S 103JTH	J24189037		1-	B	b2
R 1226	CHIP RES.	100k	1/16W	5%	RMC1/16S 104JTH	J24189049		1-	B	b2
R 1227	CHIP RES.	2.2M	1/16W	5%	RMC1/16S 225JTH	J24189065		1-	A	C6
R 1228	CHIP RES.	2.2k	1/16W	5%	RMC1/16S 222JTH	J24189029		1-	A	C7
R 1229	CHIP RES.	10k	1/16W	5%	RMC1/16S 103JTH	J24189037		1-	A	C6
R 1230	CHIP RES.	2.7k	1/16W	5%	RMC1/16S 272JTH	J24189030		1-	B	c7
R 1231	CHIP RES.	10k	1/16W	5%	RMC1/16S 103JTH	J24189037		1-	A	D6
R 1232	CHIP RES.	220	1/16W	5%	RMC1/16S 221JTH	J24189017		1-	B	d2
R 1233	CHIP RES.	150	1/16W	5%	RMC1/16S 151JTH	J24189015		1-	B	a4
R 1234	CHIP RES.	100k	1/16W	5%	RMC1/16S 104JTH	J24189049		1-	A	B3
R 1235	CHIP RES.	82k	1/16W	5%	RMC1/16S 823JTH	J24189048		1-	B	c7
R 1236	CHIP RES.	22k	1/16W	5%	RMC1/16S 223JTH	J24189041		1-	A	D1
R 1237	CHIP RES.	22k	1/16W	5%	RMC1/16S 223JTH	J24189041		1-	A	D1
R 1238	CHIP RES.	100	1/16W	5%	RMC1/16S 101JTH	J24189013		1-	A	B2
R 1239	CHIP RES.	22k	1/16W	5%	RMC1/16S 223JTH	J24189041		1-	B	d5
R 1241	CHIP RES.	22k	1/16W	5%	RMC1/16S 223JTH	J24189041		1-	B	d5
R 1243	CHIP RES.	0.2	1/2W	1%	RLC32-R200FTP	J24279031		1-	A	E3
R 1244	CHIP RES.	100k	1/16W	5%	RMC1/16S 104JTH	J24189049		1-	A	B2
R 1245	CHIP RES.	4.7k	1/16W	5%	RMC1/16S 472JTH	J24189033		1-	A	B2

MAIN Unit

Parts List

REF	DESCRIPTION	VALUE	V/W	TOL.	MFR'S DESIG	VXSTD P/N	VERS.	LOT	SIDE	LAY ADR
R 1246	CHIP RES.	330k	1/16W	5%	RMC1/16S 334JTH	J24189055		1-	A	E2
R 1247	CHIP RES.	100k	1/16W	5%	RMC1/16S 104JTH	J24189049		1-	A	B2
R 1248	CHIP RES.	10k	1/16W	5%	RMC1/16S 103JTH	J24189037		1-		
R 1249	CHIP RES.	10k	1/16W	5%	RMC1/16S 103JTH	J24189037		1-		
R 1250	CARBON FILM RES.	100k	1/6W	5%	RD16TPJ104 100K	J07225104		1-		
S 1008	ROTARY ENCODER				TP70D00E20 RY-7344	Q9000801		1-	B	a1
TH1001	THERMISTOR				ERTJ1VV473J	G9090122		1-	B	d6
TH1002	THERMISTOR				ERTJ1VV473J	G9090122		1-	A	B4
X 1001	XTAL TSS-6	11.7MHz			TSS-5032A 11.7MHZ	H0103264		1-	B	d6
X 1002	XTAL AT-38	3.579545MHz			3.579545MHZ	H0103292		1-	A	D3
XF1001	XTAL FILTER	47.25MHz			MF47R2 47.25MHZ	H1102347		1-	B	a4
	INTER CONNECTOR FRAME LIGHT GUIDE LCD SHEET				(LCD) (LCD)	RA050410A RA0504000 RA0503500 RA0034400		1- 1- 1- 1-		

Downloaded by
 RadioAmateur.EU

Filter Unit

Circuit Diagram

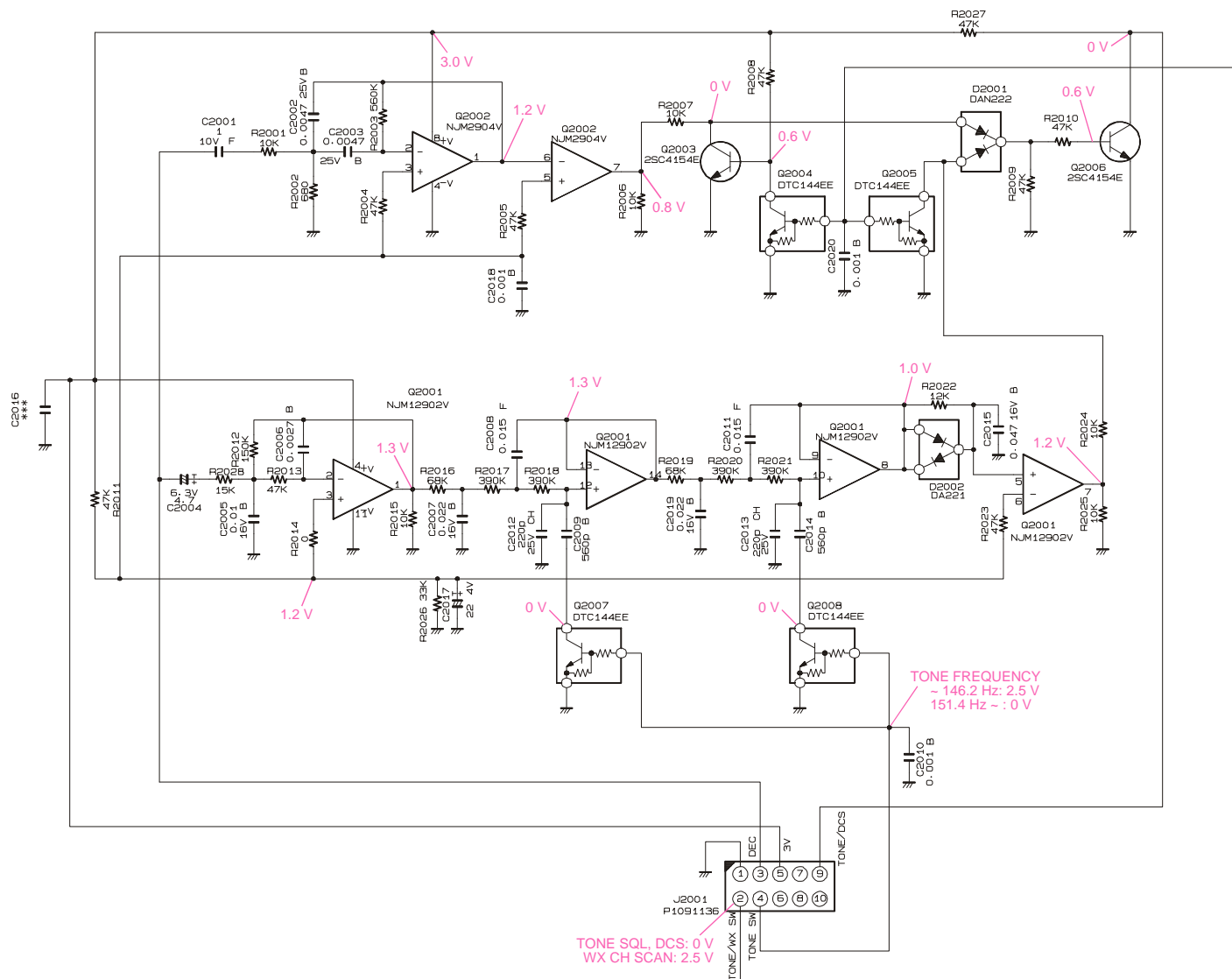

Filter Unit

Parts Layout

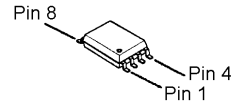
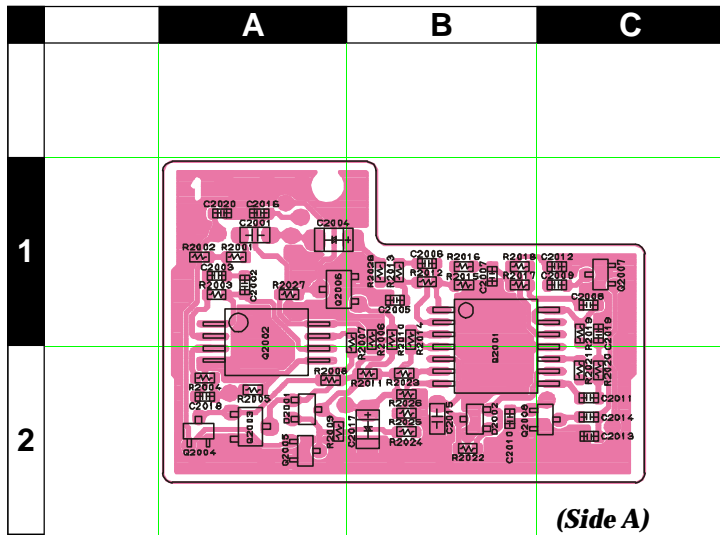

NJM2904R
(Q2002)

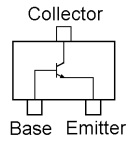

2SC4154 (LE)
(Q2003, 2006)

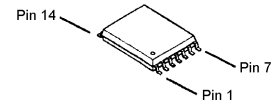

NJM12902V
(Q2001)

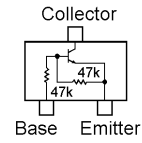

DTC144EE (LE)
(Q2004, 2005, 2007,
2008)

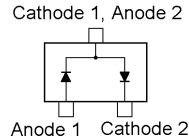
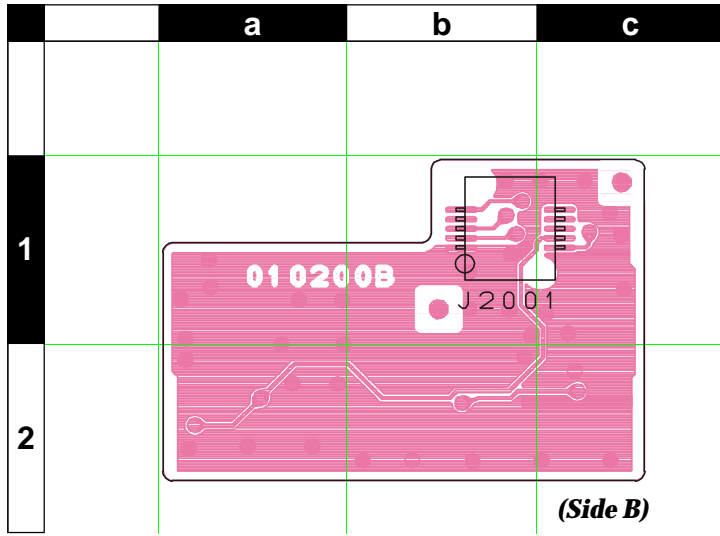

DA221M (K)
(D2002)

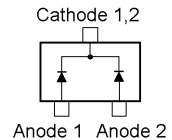

DAN222M (N)
(D2001)

Filter Unit

Parts List

REF	DESCRIPTION	VALUE	V/W	TOL.	MFR'S DESIG	VXSTD P/N	VERS.	LOT	SIDE	LAY ADR	
PCB with Components						CB2397001					
Printed Circuit Board						AH015M000	FR0102000		1-		
C 2001	CHIP CAP.	1uF	10V	F	GRM39F105Z10PT	K22105001		1-	A	A1	
C 2002	CHIP CAP.	0.0047uF	25V	B	TMK105B472KW-F	K22148831		1-	A	A1	
C 2003	CHIP CAP.	0.0047uF	25V	B	TMK105B472KW-F	K22148831		1-	A	A1	
C 2004	CHIP TA.CAP.	4.7uF	6.3V		TESVSP0J475M-8R	K78080053		1-	A	A1	
C 2005	CHIP CAP.	0.01uF	16V	B	GRM36B103K16PT	K22128804		1-	A	B1	
C 2006	CHIP CAP.	0.0027uF	50V	B	UMK105B272KW-F	K22178834		1-	A	B1	
C 2007	CHIP CAP.	0.022uF	16V	B	GRM36B223K16PT	K22128806		1-	A	B1	
C 2008	CHIP CAP.	0.015uF	50V	F	UMK105F153ZW-F	K22179018		1-	A	C1	
C 2009	CHIP CAP.	560pF	50V	B	UMK105B561KW-F	K22178826		1-	A	C1	
C 2010	CHIP CAP.	0.001uF	50V	B	UMK105B102KW-F	K22178829		1-	A	B2	
C 2011	CHIP CAP.	0.015uF	50V	F	UMK105F153ZW-F	K22179018		1-	A	C2	
C 2012	CHIP CAP.	220pF	25V	CH	TMK105CH221JW-F	K22148246		1-	A	C1	
C 2013	CHIP CAP.	220pF	25V	CH	TMK105CH221JW-F	K22148246		1-	A	C2	
C 2014	CHIP CAP.	560pF	50V	B	UMK105B561KW-F	K22178826		1-	A	C2	
C 2015	CHIP CAP.	0.047uF	16V	B	GRM39B473K16PT	K22124804		1-	A	B2	
C 2017	CHIP TA.CAP.	22uF	4V		TESVSP0G226M-8R	K78060047		1-	A	B2	
C 2018	CHIP CAP.	0.001uF	50V	B	UMK105B102KW-F	K22178829		1-	A	A2	
C 2019	CHIP CAP.	0.022uF	16V	B	GRM36B223K16PT	K22128806		1-	A	C1	
C 2020	CHIP CAP.	0.001uF	50V	B	UMK105B102KW-F	K22178829		1-	A	A1	
D 2001	DIODE				DAN222 TL	G2070174		1-	A	A2	
D 2002	DIODE				DA221 TL	G2070178		1-	A	B2	
J 2001	CONNECTOR				AXK5F10335P	P1091136		1-	B	b1	
Q 2001	IC				NJM12902V(TE1)	G1093592		1-	A	B1	
Q 2002	IC				NJM2904V-TE1	G1091677		1-	A	A1	
Q 2003	TRANSISTOR				2SC4154-T11-1E	G3341548E		1-	A	A2	
Q 2004	TRANSISTOR				DTC144EE TL	G3070075		1-	A	A2	
Q 2005	TRANSISTOR				DTC144EE TL	G3070075		1-	A	A2	
Q 2006	TRANSISTOR				2SC4154-T11-1E	G3341548E		1-	A	A1	
Q 2007	TRANSISTOR				DTC144EE TL	G3070075		1-	A	C1	
Q 2008	TRANSISTOR				DTC144EE TL	G3070075		1-	A	C2	
R 2001	CHIP RES.	10k	1/16W	5%	RMC1/16S 103JTH	J24189037		1-	A	A1	
R 2002	CHIP RES.	680	1/16W	5%	RMC1/16S 681JTH	J24189023		1-	A	A1	
R 2003	CHIP RES.	560k	1/16W	5%	RMC1/16S 564JTH	J24189058		1-	A	A1	
R 2004	CHIP RES.	47k	1/16W	5%	RMC1/16S 473JTH	J24189045		1-	A	A2	
R 2005	CHIP RES.	47k	1/16W	5%	RMC1/16S 473JTH	J24189045		1-	A	A2	
R 2006	CHIP RES.	10k	1/16W	5%	RMC1/16S 103JTH	J24189037		1-	A	B1	
R 2007	CHIP RES.	10k	1/16W	5%	RMC1/16S 103JTH	J24189037		1-	A	B1	
R 2008	CHIP RES.	47k	1/16W	5%	RMC1/16S 473JTH	J24189045		1-	A	A2	
R 2009	CHIP RES.	47k	1/16W	5%	RMC1/16S 473JTH	J24189045		1-	A	A2	
R 2010	CHIP RES.	47k	1/16W	5%	RMC1/16S 473JTH	J24189045		1-	A	B1	
R 2011	CHIP RES.	47k	1/16W	5%	RMC1/16S 473JTH	J24189045		1-	A	B2	
R 2012	CHIP RES.	150k	1/16W	5%	RMC1/16S 154JTH	J24189051		1-	A	B1	
R 2013	CHIP RES.	47k	1/16W	5%	RMC1/16S 473JTH	J24189045		1-	A	B1	
R 2014	CHIP RES.	0	1/16W	5%	RMC1/16S JPTH	J24189070		1-	A	B1	
R 2015	CHIP RES.	10k	1/16W	5%	RMC1/16S 103JTH	J24189037		1-	A	B1	
R 2016	CHIP RES.	68k	1/16W	5%	RMC1/16S 683JTH	J24189047		1-	A	B1	
R 2017	CHIP RES.	390k	1/16W	5%	RMC1/16S 394JTH	J24189056		1-	A	B1	
R 2018	CHIP RES.	390k	1/16W	5%	RMC1/16S 394JTH	J24189056		1-	A	B1	
R 2019	CHIP RES.	68k	1/16W	5%	RMC1/16S 683JTH	J24189047		1-	A	C1	
R 2020	CHIP RES.	390k	1/16W	5%	RMC1/16S 394JTH	J24189056		1-	A	C2	
R 2021	CHIP RES.	390k	1/16W	5%	RMC1/16S 394JTH	J24189056		1-	A	C2	
R 2022	CHIP RES.	12k	1/16W	5%	RMC1/16S 123JTH	J24189038		1-	A	B2	
R 2023	CHIP RES.	47k	1/16W	5%	RMC1/16S 473JTH	J24189045		1-	A	B2	
R 2024	CHIP RES.	10k	1/16W	5%	RMC1/16S 103JTH	J24189037		1-	A	B2	
R 2025	CHIP RES.	10k	1/16W	5%	RMC1/16S 103JTH	J24189037		1-	A	B2	
R 2026	CHIP RES.	33k	1/16W	5%	RMC1/16S 333JTH	J24189043		1-	A	B2	
R 2027	CHIP RES.	47k	1/16W	5%	RMC1/16S 473JTH	J24189045		1-	A	A1	
R 2028	CHIP RES.	15k	1/16W	5%	RMC1/16S 153JTH	J24189039		1-	A	B1	

Filter Unit

Note

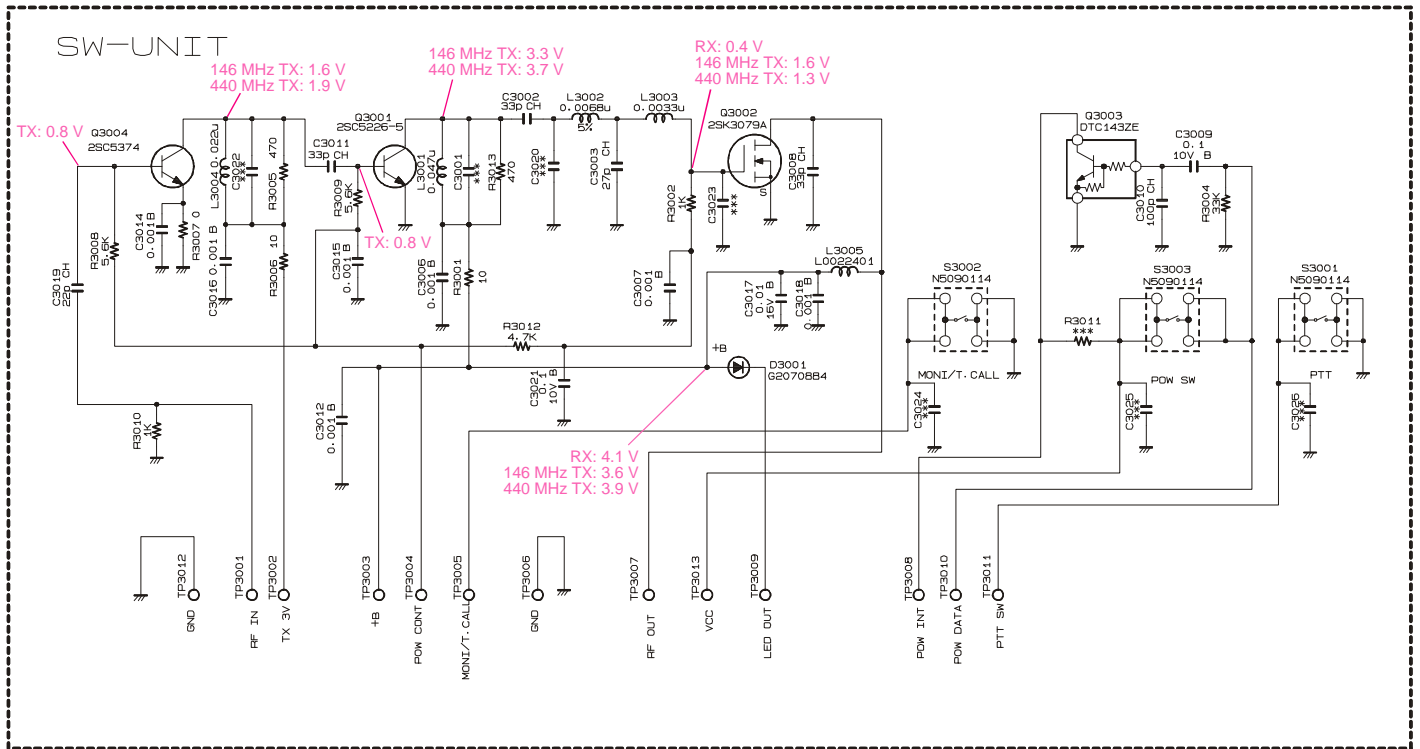

Parts Layout

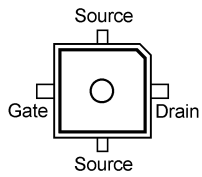

2SK3079A (E23)
(Q3002)

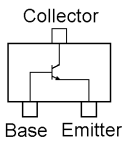

2SC5226 (R22)
(Q3001)
2SC5374 (NA)
(Q3004)

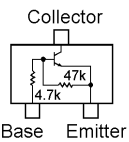

DTC143ZE (E23)
(Q3003)

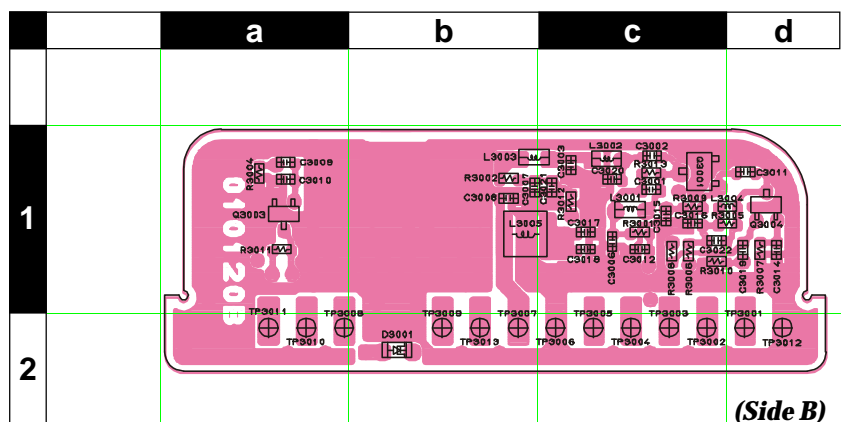
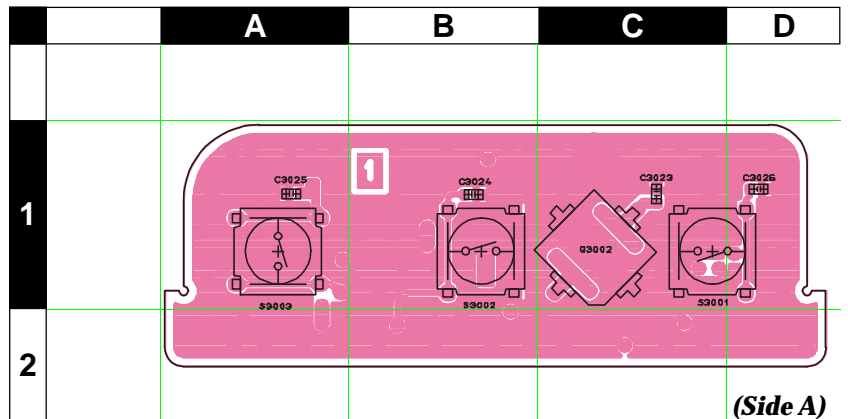

SW Unit

Parts List

REF	DESCRIPTION	VALUE	V/W	TOL.	MFR'S DESIG	VXSTD P/N	VERS.	LOT	SIDE	LAY ADR
PCB with Components						CS1789001				
Printed Circuit Board						AH015M000	FR0101200	1-		
C 3002	CHIP CAP.	33pF	50V	CH	UMK105CH330JW-F	K22178270		1-	B	c1
C 3003	CHIP CAP.	27pF	50V	CH	UMK105CH270JW-F	K22178268		1-	B	c1
C 3006	CHIP CAP.	0.001uF	50V	B	UMK105B102KW-F	K22178829		1-	B	c1
C 3007	CHIP CAP.	0.001uF	50V	B	UMK105B102KW-F	K22178829		1-	B	b1
C 3008	CHIP CAP.	33pF	50V	CH	UMK105CH330JW-F	K22178270		1-	B	b1
C 3009	CHIP CAP.	0.1uF	10V	B	GRM36B104K10PT	K22108802		1-	B	a1
C 3010	CHIP CAP.	100pF	50V	CH	UMK105CH101JW-F	K22178282		1-	B	a1
C 3011	CHIP CAP.	33pF	50V	CH	UMK105CH330JW-F	K22178270		1-	B	d1
C 3012	CHIP CAP.	0.001uF	50V	B	UMK105B102KW-F	K22178829		1-	B	c1
C 3014	CHIP CAP.	0.001uF	50V	B	UMK105B102KW-F	K22178829		1-	B	d1
C 3015	CHIP CAP.	0.001uF	50V	B	UMK105B102KW-F	K22178829		1-	B	c1
C 3016	CHIP CAP.	0.001uF	50V	B	UMK105B102KW-F	K22178829		1-	B	c1
C 3017	CHIP CAP.	0.01uF	16V	B	GRM36B103K16PT	K22128804		1-	B	c1
C 3018	CHIP CAP.	0.001uF	50V	B	UMK105B102KW-F	K22178829		1-	B	c1
C 3019	CHIP CAP.	22pF	50V	CH	UMK105CH220JW-F	K22178266		1-	B	d1
C 3021	CHIP CAP.	0.1uF	10V	B	GRM36B104K10PT	K22108802		1-	B	c1
D 3001	LED				19-215UYOC/S530-A2/TR8	G2070884		1-	B	b2
L 3001	M.RFC	0.047uH			ELJ-RE47NJF2	L1690722		1-	B	c1
L 3002	M.RFC	0.0068uH		5%	C1608CA-6N8J	L1691093		1-	B	c1
L 3003	M.RFC	0.0033uH			ELJ-RE3N3DF2	L1690708		1-	B	b1
L 3004	M.RFC	0.022uH			TFL0510-22N	L1690815		1-	B	c1
L 3005	COIL				E2 0.25-1.9-6.5T-L	L0022401		1-	B	b1
Q 3001	TRANSISTOR				2SC5226-5-TL	G3352268E		1-	B	c1
Q 3002	FET				2SK3079A(TE12L)	G3830798		1-	A	C1
Q 3003	TRANSISTOR				DTC143ZE TL	G3070102		1-	B	a1
Q 3004	TRANSISTOR				2SC5374-TL	G3353748		1-	B	d1
R 3001	CHIP RES.	10	1/16W	5%	RMC1/16S 100JTH	J24189001		1-	B	c1
R 3002	CHIP RES.	1k	1/16W	5%	RMC1/16S 102JTH	J24189025		1-	B	b1
R 3004	CHIP RES.	33k	1/16W	5%	RMC1/16S 333JTH	J24189043		1-	B	a1
R 3005	CHIP RES.	470	1/16W	5%	RMC1/16S 471JTH	J24189021		1-	B	c1
R 3006	CHIP RES.	10	1/16W	5%	RMC1/16S 100JTH	J24189001		1-	B	c1
R 3007	CHIP RES.	0	1/16W	5%	RMC1/16S JPTH	J24189070		1-	B	d1
R 3008	CHIP RES.	5.6k	1/16W	5%	RMC1/16S 562JTH	J24189034		1-	B	c1
R 3009	CHIP RES.	5.6k	1/16W	5%	RMC1/16S 562JTH	J24189034		1-	B	c1
R 3010	CHIP RES.	1k	1/16W	5%	RMC1/16S 102JTH	J24189025		1-	B	c1
R 3012	CHIP RES.	4.7k	1/16W	5%	RMC1/16S 472JTH	J24189033		1-	B	c1
R 3013	CHIP RES.	470	1/16W	5%	RMC1/16S 471JTH	J24189021		1-	B	c1
S 3001	TACT SWITCH				SOT-154HST R66-5552	N5090114		1-	A	C1
S 3002	TACT SWITCH				SOT-154HST R66-5552	N5090114		1-	A	B1
S 3003	TACT SWITCH				SOT-154HST R66-5552	N5090114		1-	A	A1

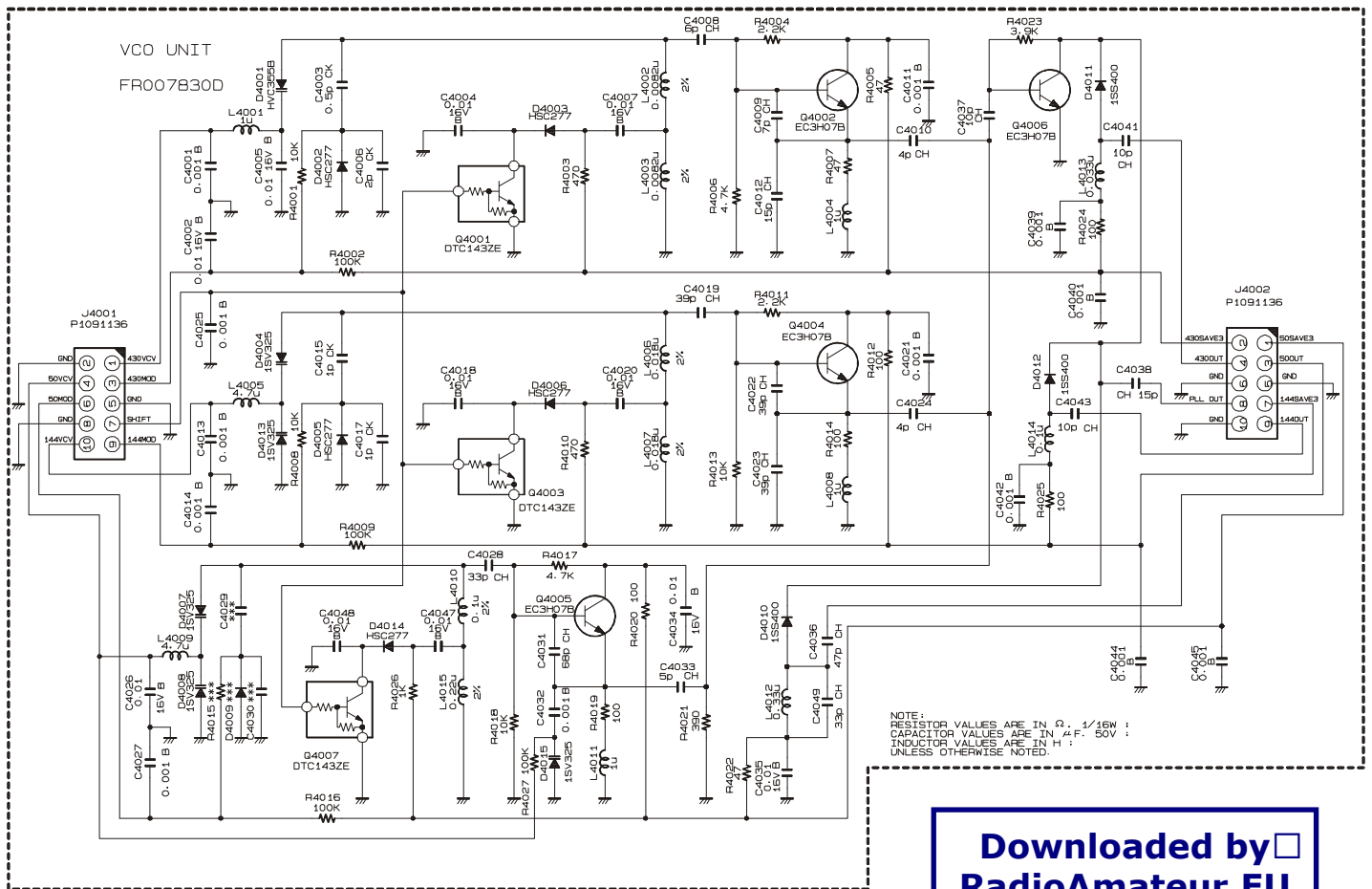

Downloaded by
 RadioAmateur.EU

VCO Unit

Parts Layout

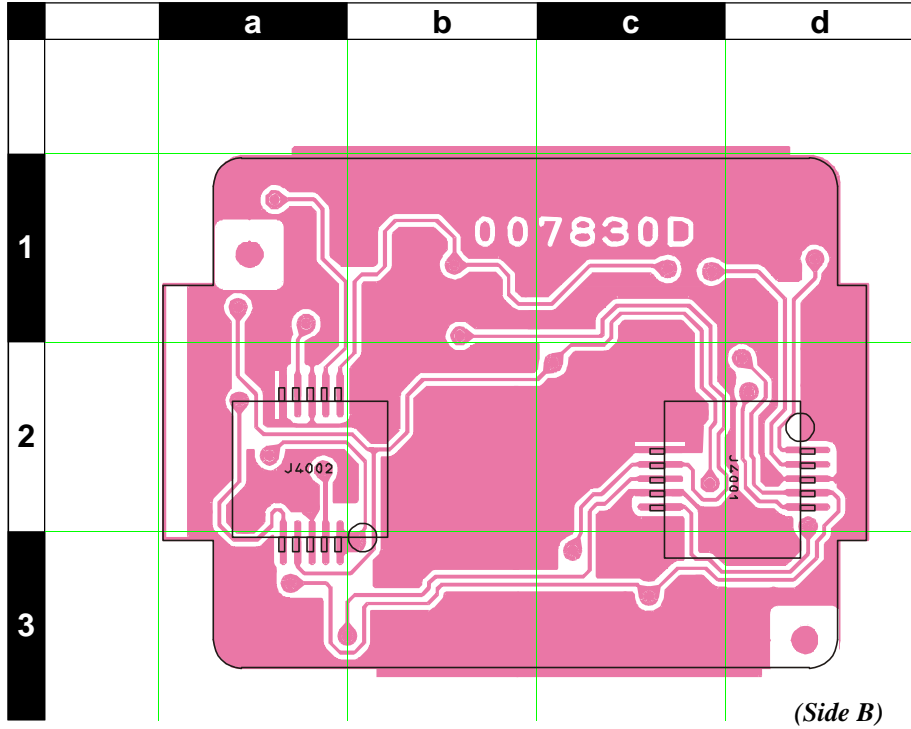
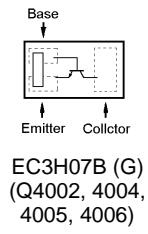
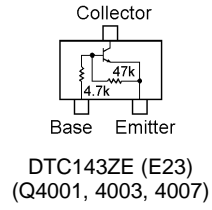
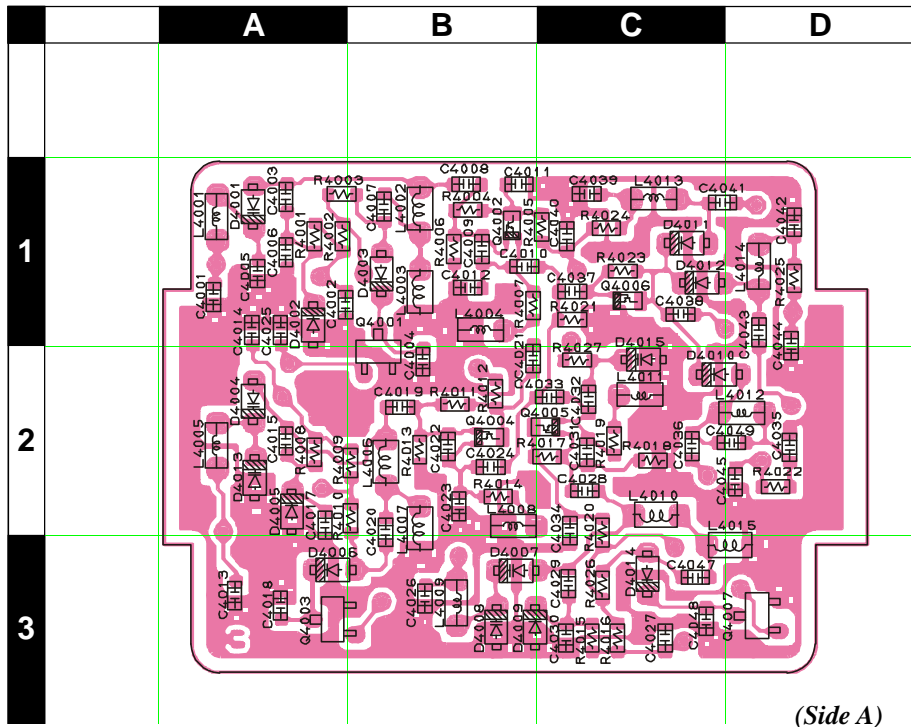

VCO Unit

Parts List

REF	DESCRIPTION	VALUE	V/W	TOL.	MFR'S DESIG	VXSTD P/N	VERS.	LOT	SIDE	LAY ADR
L 4011	M.RFC	1uH			LK1608 1R0K-T	L1690687		1-	A	B2
L 4012	M.RFC	0.33uH			LK1608 R33K-T	L1690412		1-	A	B2
L 4013	M.RFC	0.033uH			HK1608 33NJ-T	L1690522		1-	A	B2
L 4014	M.RFC	0.1uH			LK1608 R10K-T	L1690407		1-	A	C2
L 4015	M.RFC	0.22uH		2%	C1608CA-R22G	L1691103		1-	A	B3
Q 4001	TRANSISTOR				DTC143ZE TL	G3070102		1-	A	A2
Q 4002	TRANSISTOR				EC3H07B-TL	G3070286		1-	A	B2
Q 4003	TRANSISTOR				DTC143ZE TL	G3070102		1-	A	A3
Q 4004	TRANSISTOR				EC3H07B-TL	G3070286		1-	A	B2
Q 4005	TRANSISTOR				EC3H07B-TL	G3070286		1-	A	B2
Q 4006	TRANSISTOR				EC3H07B-TL	G3070286		1-	A	B2
Q 4007	TRANSISTOR				DTC143ZE TL	G3070102		1-	A	B3
R 4001	CHIP RES.	10k	1/16W	5%	RMC1/16S 103JTH	J24189037		1-	A	A2
R 4002	CHIP RES.	100k	1/16W	5%	RMC1/16S 104JTH	J24189049		1-	A	A2
R 4003	CHIP RES.	470	1/16W	5%	RMC1/16S 471JTH	J24189021		1-	A	A2
R 4004	CHIP RES.	2.2k	1/16W	5%	RMC1/16S 222JTH	J24189029		1-	A	A2
R 4005	CHIP RES.	47	1/16W	5%	RMC1/16S 470JTH	J24189009		1-	A	B2
R 4006	CHIP RES.	4.7k	1/16W	5%	RMC1/16S 472JTH	J24189033		1-	A	A2
R 4007	CHIP RES.	47	1/16W	5%	RMC1/16S 470JTH	J24189009		1-	A	B2
R 4008	CHIP RES.	10k	1/16W	5%	RMC1/16S 103JTH	J24189037		1-	A	A2
R 4009	CHIP RES.	100k	1/16W	5%	RMC1/16S 104JTH	J24189049		1-	A	A2
R 4010	CHIP RES.	470	1/16W	5%	RMC1/16S 471JTH	J24189021		1-	A	A3
R 4011	CHIP RES.	2.2k	1/16W	5%	RMC1/16S 222JTH	J24189029		1-	A	A2
R 4012	CHIP RES.	100	1/16W	5%	RMC1/16S 101JTH	J24189013		1-	A	B2
R 4013	CHIP RES.	10k	1/16W	5%	RMC1/16S 103JTH	J24189037		1-	A	A2
R 4014	CHIP RES.	100	1/16W	5%	RMC1/16S 101JTH	J24189013		1-	A	B3
R 4016	CHIP RES.	100k	1/16W	5%	RMC1/16S 104JTH	J24189049		1-	A	B3
R 4017	CHIP RES.	4.7k	1/16W	5%	RMC1/16S 472JTH	J24189033		1-	A	B2
R 4018	CHIP RES.	10k	1/16W	5%	RMC1/16S 103JTH	J24189037		1-	A	B2
R 4019	CHIP RES.	100	1/16W	5%	RMC1/16S 101JTH	J24189013		1-	A	B2
R 4020	CHIP RES.	100	1/16W	5%	RMC1/16S 101JTH	J24189013		1-	A	B3
R 4021	CHIP RES.	390	1/16W	5%	RMC1/16S 391JTH	J24189020		1-	A	B2
R 4022	CHIP RES.	47	1/16W	5%	RMC1/16S 470JTH	J24189009		1-	A	C3
R 4023	CHIP RES.	3.9k	1/16W	5%	RMC1/16S 392JTH	J24189032		1-	A	B2
R 4024	CHIP RES.	100	1/16W	5%	RMC1/16S 101JTH	J24189013		1-	A	B2
R 4025	CHIP RES.	100	1/16W	5%	RMC1/16S 101JTH	J24189013		1-	A	C2
R 4026	CHIP RES.	1k	1/16W	5%	RMC1/16S 102JTH	J24189025		1-	A	B3
R 4027	CHIP RES.	100k	1/16W	5%	RMC1/16S 104JTH	J24189049		1-	A	B2
	SHIELD CASE VCO					RA0400300		1-		
	SHIELD SHEET					RA043430A		1-		



Copyright 2003
VERTEX STANDARD CO., LTD.
All rights reserved

No portion of this manual
may be reproduced without
the permission of
VERTEX STANDARD CO., LTD.

Downloaded by
RadioAmateur.EU